



# DeSign

 **ALU**  
VISUAL ALUMINIUM EXCELLENCE

GUIDEBOOK SEMI-FINISHED PRODUCTS

*Way Finding Solutions*



Triline® DeSign is a complete new line for interior and exterior signage in a straight design, selected to be the trend for the coming decades.

The DeSign product line excels through its elegant simplicity. It is classic in approach but extremely multifunctional, thus being suitable for applications in merely every architectural context.



- An everlasting concept with straight panels
- System for installation with clips
- Wall Signs
- Transverse Signs
- Suspension Signs
- Antivandalism and anti-theft end caps features
- Modular with inexhaustible combinations
- Synthetic end caps
- Aluminium side-track system available in three shapes (Classic, Radius, Triangle)
- 9 standard heights in face profiles
- 6 standard heights in insert profiles for material thickness up to 1,75 mm
- 2 variable insert profiles adaptable to any size
- Simple aluminium system complying with architectural expectations and safety regulations

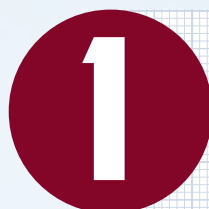

## DeSign

ALU  
VISUAL ALUMINIUM EXCELLENCE

	page
Aluminium profiles & Synthetic parts	1.2
Door signs	1.4
Wall signs	1.16
Flag signs	1.18
Suspended signs	1.20
Directory signs	1.22
Desk stands	1.26
Din measures	1.28
Emergency signs	1.30

**Face profiles**

The face profiles have a material thickness from 1.5mm / 0.06" up to 3mm / 0.12", allowing engraving and Braille applications.

**Insert profiles**

The insert profiles offer the possibility to insert any kind of material with a thickness up to 1.75mm / 0.069".

**Panel & supporting profile**

These variable insert profiles offer the possibility to create any type and measure of insert panels larger than A4 (for example A3, A2, A1), and to integrate for example maps in large directories.

**Side track profiles**

Side track profiles can be used in any application, both in small door signs and in larger directories.

**Intermediate profile**

Intermediate profiles are only to be used in combination with side track profiles:

- TLEKC
- TLEKR

**Suspension system**

The connecting parts of the suspension system TLOPH are made of aluminium in order to guarantee safety in case of fire, and to perform easy and smooth maintenance and / or replacement of suspension signs. The steelwire of 1.5mm/0.06" thickness has a portable force of 160kg/350 pounds (tested). The face profiles will remain hanging from the connectors (TLEST/TLDST) thanks to the seamless fitting of the profile to the connecting piece.

Article code	width frame	Insert measures
TL31-B	31mm / 1.22"	-
TL31S-B	31mm / 1.22"	23mm / 1.02"
TL62-B	62mm / 2.44"	-
TL62S-B	62mm / 2.44"	57mm / 2.24"
TL93-B	93mm / 3.66"	-
TL93S-B	93mm / 3.66"	88mm / 3.46"
TL124-B	124mm / 4.88"	-
TL155-B	155mm / 6.1"	-
TL155S-B	155mm / 6.1"	149,4mm / 5.88"
TL186-B	186mm / 7.3"	-
TL217-B	217mm / 8.54"	-
TL217S-B	217mm / 8.54"	212mm / 8.35"
TL248-B	248mm / 9.76"	-

**Decipher the Triline® code**

Face and insert profiles	Single and double end caps
TL = Triline <sup>?</sup>	TL = Triline <sup>?</sup>
31 = 31mm width profile	E = Single end cap D = Double end cap
S = insert profile	93 = 93mm length end cap
-B = mill finish	-B = black
-S = silver anodised	-G = grey
-G = gold anodised	

**Top & bottom profiles**

Top & bottom profiles are only used in combination with side track profiles.

**Support profile**

We recommend to install this invisible support profile (vertical), when the individual horizontal profiles are longer than 80cm / 3.15".



# Aluminium profiles & Synthetic parts

## Single end caps

Anti-vandalism end caps (patented) for wall fixation. To be used in combination with the TLCLJ clips.

The synthetic end caps are made of polyprop and glass fibred, this combination guarantees an extensive flexibility, without breaking.

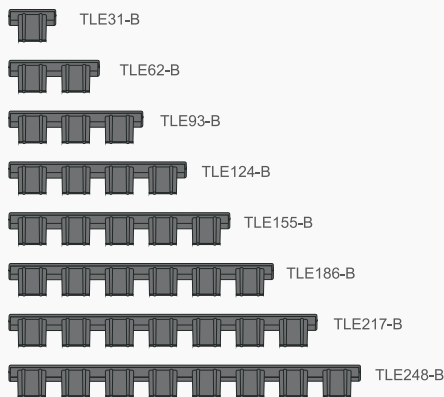

## Blocking pin / side tracks

TLAND is a patented anti-theft blocking pin for securing all types of wall mounted signs assembled with side tracks.

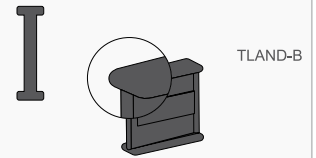

## Double end caps

End caps for mounting of double-sided profiles (transverse fixation (flags), and suspended systems).

The synthetic end caps are made of polyprop and glass fibred, this combination guarantees an extensive flexibility, without breaking.

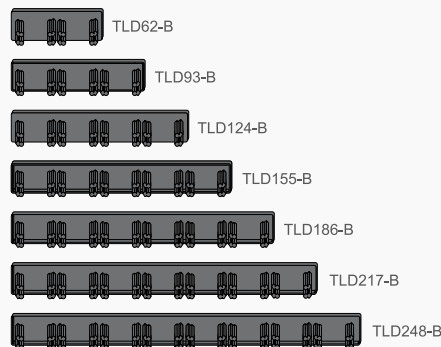

## Blocking pin / desk stands

TLDBW is a patented blocking pin, necessary for blocking the profiles in the end caps for desk stands.



## Desk stand end caps

Available in two measures:

**TLDW31:** for profiles (front and back) with a height of 31mm / 1.22"

**TLDW62:** for profiles (front and/or back) with a height of 62mm / 2.44" or two 31mm / 1.22"

The assembling of the desk stands is always in combination with the TLDBW blocking pin.

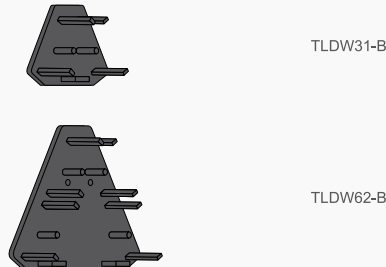

## Blocking pin / double end cap

TLDWA is a patented blocking pin to guarantee the blocking of the aluminium profiles into the double end caps for the transverse and the suspension signs.

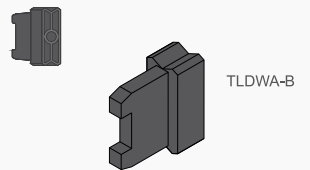

## Screw

TLSCR3 is used to lock the side track caps or classic frame corners and to ensure the correct blocking of the TLCLI/TLCLJ clips in the side



## Side track caps

Side track caps are only used in combination with side track profiles.

TLCLAS with TLEKC  
TLRADS with TLEKR  
TLJAZS with TLJAZ2



## Frame corners

These are only used in combination with side track profiles and top & bottom profiles

TLHCS with TLEKC, TLCLAT  
TLHRA with TLEKR, TLRAD

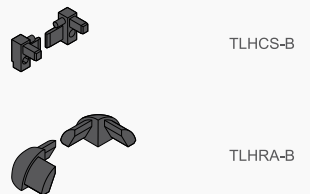

## Clips

TLCLJ is a patented clip to be used in combination with single synthetic end caps and the TLJAZ2 side track.

TLCLI is used in combination with TLEKC and TLEKR side tracks, intermediate profiles and support profiles.

These clips guarantee an extensive flexibility, without breaking.

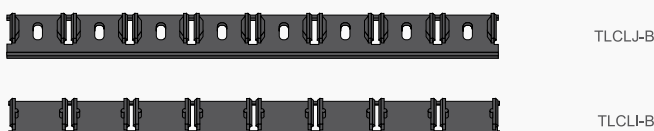

## Triline key

TLKEY is created to unlock the profiles from their clips and replace a profile in a directory without disassembling the signs.

The key has a stainless steel insert piece with a synthetic handle.

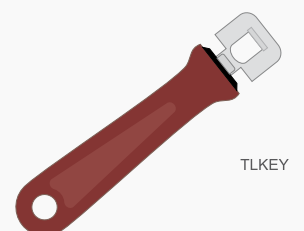

## Assembling

The aluminum profiles (face and/or insert) will be snapped on the clips and finished with synthetic **anti-vandalism end caps** (from 31mm to 248mm).  
Easy assembly.

Ideal for personnel signs, room identification, wall projection signs, emergency signage and more.



### APPLICATIONS

Triline® profiles

Vinyl lettering  
Digital printing  
Engraving  
ADA  
Braille text  
Screen printing

### MOUNTING POSSIBILITIES

Wall

1

With screw and plug.

2

Double tape ( At01),  
to be used with  
special cleaning  
product (Ac02).

3

Glued with Sticky  
Bond (Ag01)

- ✓ Anti-vandalism end caps
- ✓ Easy assembly

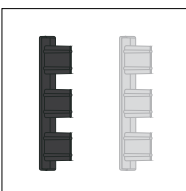
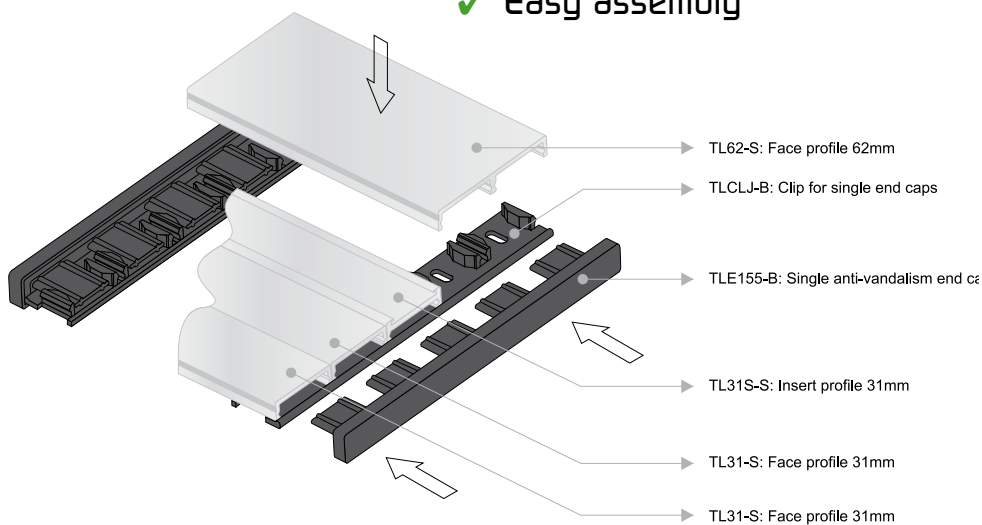

**Single end caps**  
Standard colours

- Black
- Grey

Please contact your local distributor for other colours, prices and delivery terms.



**Profiles** have a standard length of 3500mm / 137.80"  
Standard finishes

- Mill finish
- Silver anodized
- Gold anodized





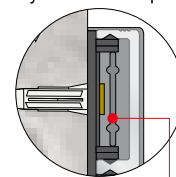

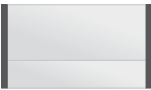
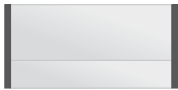
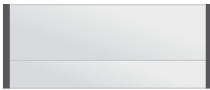
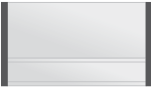
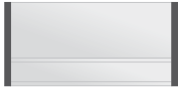
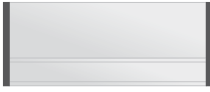
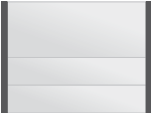
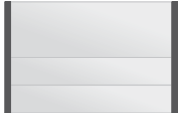
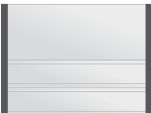
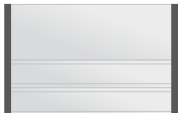
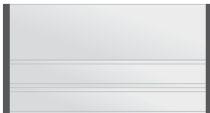
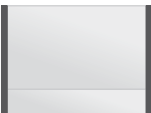

Please contact your local distributor for other finishes, lengths, prices and delivery terms.

**Cross-section**  
Synthetic end caps

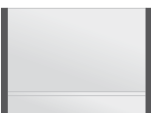
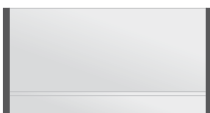

Anti-vandalism end cap

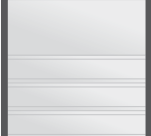
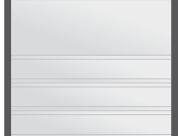
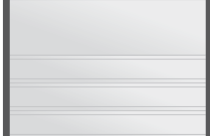
# DeSign Synthetic end caps

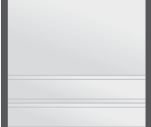
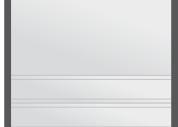
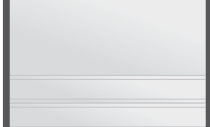
155mm			186mm			217mm			
	Ds101			Ds102			Ds103		93
									62mm
									31mm
	Ds104			Ds105			Ds106		62mm
									31mm s
155mm			186mm			217mm			
	Ds107			Ds108			Ds109		124
									62mm
									31mm
									31mm
	Ds110			Ds111			Ds112		62mm
									31mm s
									31mm s
	Ds113			Ds114			Ds115		93mm
									31mm
	Ds116			Ds117			Ds118		93mm
									31mm s
155mm			186mm			217mm			
	Ds119			Ds120			Ds121		155
									62mm
									31mm
									31mm
									31mm
	Ds122			Ds123			Ds124		62mm
									31mm s
									31mm s
									31mm s
	Ds125			Ds126			Ds127		93mm
									31mm
									31mm
	Ds128			Ds129			Ds130		93mm
									31mm s
									31mm s

This is only a selection of the endless combination possibilities that the Triline® system offers. See page 17 for more options.

"S" indicates insert profiles

## Assembling

The aluminium profiles (face and/or insert) will be snapped on the clips which have previously been integrated in the side tracks, and finished with side track caps. **Anti-theft solution:** synthetic blocking pin that slides between clips. Ideal for personnel signs, room identification, directories, directional signs, and more...



### INSERTS

Triline® profiles

The insert profiles offer the possibility to insert any kind of material with a thickness up to 1.75mm / 0.069".

### MOUNTING POSSIBILITIES

Wall

- 1 With screw and plug.
- 2 Double tape (At01), to be used with special cleaning product (Ac02).
- 3 Glued with Sticky Bond (Ag01)

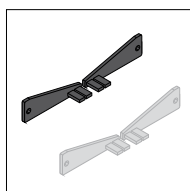

**Side track caps**  
Standard colours

- Black
- Grey

Please contact your local distributor for other colours, prices and delivery terms.

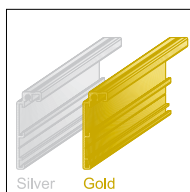

**Side track profiles** have a standard length of 3500mm / 137.80"  
Standard finishes

- Mill finish
- Silver anodized
- Gold anodized

Please contact your local distributor for other finishes, lengths, prices and delivery terms.

### ✓ Anti-theft

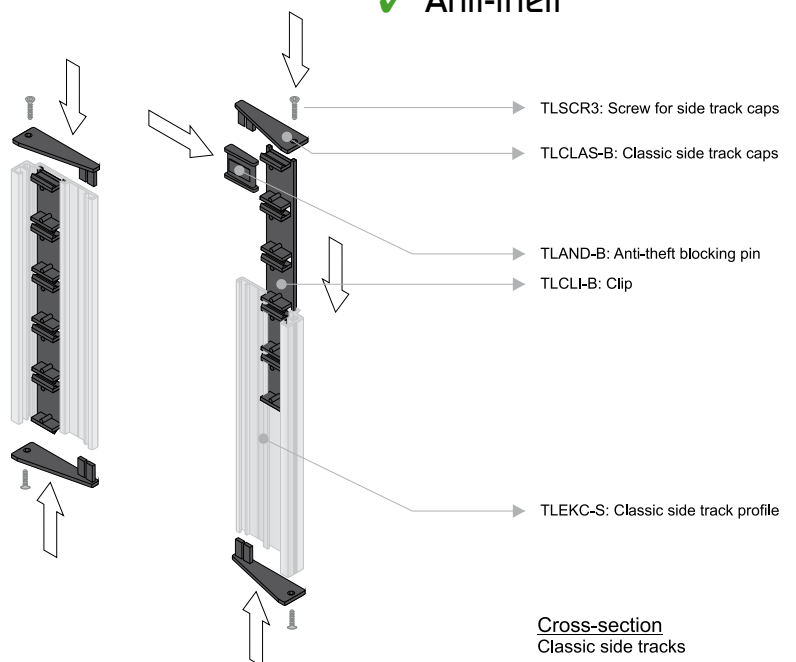

**Cross-section**  
Classic side tracks

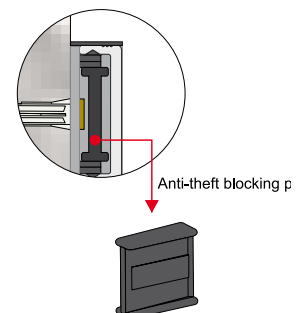



# DeSign Classic side tracks



## CLASSIC

155mm			186mm			217mm				
	Dc101			Dc102			Dc103		93 62mm 31mm	
	Dc104			Dc105			Dc106			
155mm			186mm			217mm			124	
	Dc107			Dc108			Dc109		62mm 31mm 31mm	
	Dc110			Dc111			Dc112			
	Dc113			Dc114			Dc115		62mm 31mm s 31mm s	
	Dc116			Dc117			Dc118			
155mm			186mm			217mm			155	
	Dc119			Dc120			Dc121		62mm 31mm 31mm 31mm	
	Dc122			Dc123			Dc124			
	Dc125			Dc126			Dc127		62mm 31mm s 31mm s 31mm s	
	Dc128			Dc129			Dc130			
155mm			186mm			217mm				93mm 31mm 31mm
	Dc125			Dc126			Dc127			
	Dc128			Dc129			Dc130		93mm 31mm s 31mm s	

You can't find what you need? Contact us and we will help you to find the solution!

"S" indicates insert profiles

## Assembling

Top & bottom profile to be used with classic side tracks and finished with frame corners.  
**Anti-theft sign.**  
 Ideal for personnel signs, room identification, directories, directional signs, and more...



### APPLICATIONS

Triline® profiles  
 Vinyl lettering  
 Digital printing  
 Engraving  
 ADA  
 Braille text  
 Screen printing

### MOUNTING POSSIBILITIES

Wall

- 1 With screw and plug.
- 2 Double tape ( At01), to be used with special cleaning product (Ac02).
- 3 Glued with Sticky Bond (Ag01)

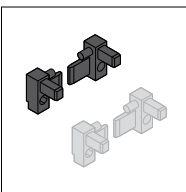

**Frame corners**  
 Standard colours

- Black
- Grey

Please contact your local distributor for other colours, prices and delivery terms.



**Top & bottom profiles** have a standard length of 3500mm / 137.80"  
 Standard finishes

- Mill finish
- Silver anodized
- Gold anodized

Please contact your local distributor for other finishes, lengths, prices and delivery terms.

✓ **Anti-theft**

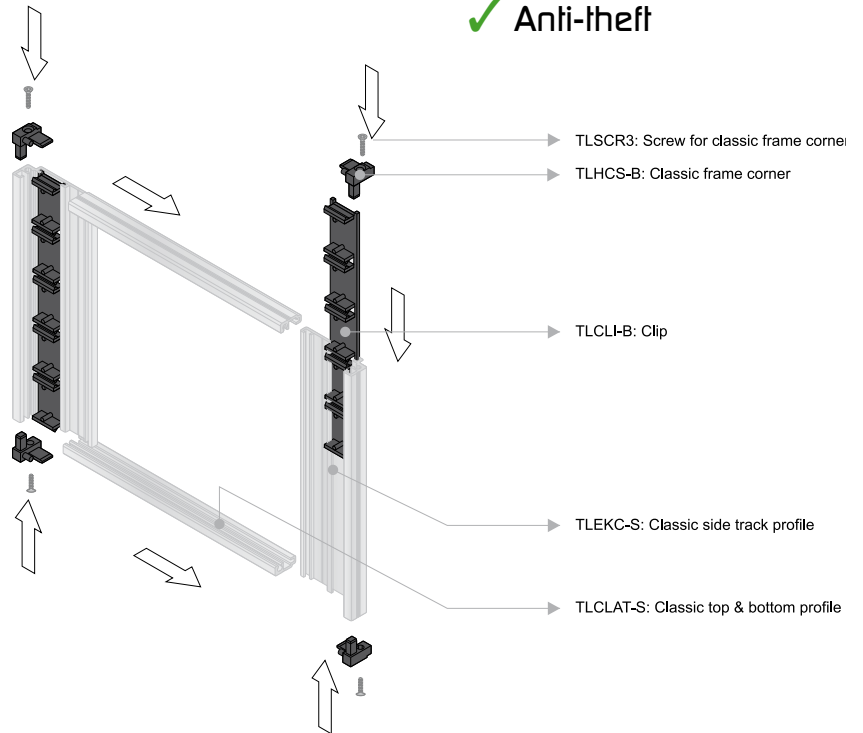

# DeSign Classic frame



## CLASSIC FRAME

155mm			186mm			217mm			
	Dc201			Dc202			Dc203		93 62mm 31mm
	Dc204			Dc205			Dc206		
									124
	Dc207			Dc208			Dc209		62mm 31mm 31mm
	Dc210			Dc211			Dc212		
	Dc213			Dc214			Dc215		62mm 31mm s 31mm s
	Dc216			Dc217			Dc218		
									155
	Dc219			Dc220			Dc221		62mm 31mm 31mm 31mm
	Dc222			Dc223			Dc224		
	Dc225			Dc226			Dc227		62mm 31mm s 31mm s 31mm s
	Dc228			Dc229			Dc230		
									93mm 31mm 31mm
									93mm 31mm s 31mm s

This is only a selection of the endless combination possibilities that the Triline® system offers. See page 17 for more options.

"S" indicates insert profiles

## Assembling

The aluminium profiles (face and/or insert) will be snapped on the clips which have previously been integrated in the side tracks, and finished with side track caps. **Anti-theft solution:** synthetic blocking pin that slides between clips. Ideal for personnel signs, room identification, directories, directional signs, and more...



### INSERTS

Triline® profiles

The insert profiles offer the possibility to insert any kind of material with a thickness up to 1.75mm / 0.069".

### MOUNTING POSSIBILITIES

Wall

- 1 With screw and plug.
- 2 Double tape (At01), to be used with special cleaning product (Ac02).
- 3 Glued with Sticky Bond (Ag01)



**Side track caps**  
Standard colours

- Black
- Grey

Please contact your local distributor for other colours, prices and delivery terms.

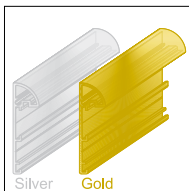

**Side track profiles** have a standard length of 3500mm / 137.80"  
Standard finishes

- Mill finish
- Silver anodized
- Gold anodized

Please contact your local distributor for other finishes, lengths, prices and delivery terms.

### ✓ Anti-theft

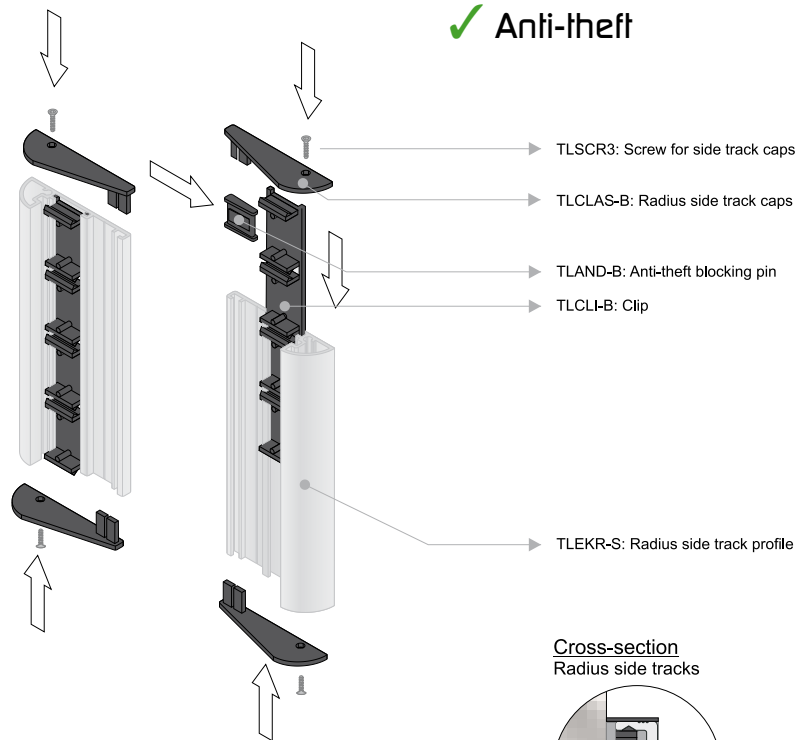

**Cross-section**  
Radius side tracks

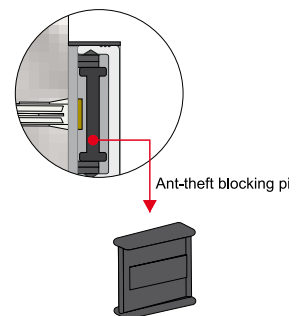



# DeSign Radius side tracks



155mm			186mm			217mm			93	
	Dr101			Dr102			Dr103		62mm	
	Dr104			Dr105			Dr106		31mm	
									62mm	
									31mm s	
155mm			186mm			217mm			124	
	Dr107			Dr108			Dr109		62mm	
	Dr110			Dr111			Dr112		31mm	
	Dr113			Dr114			Dr115		31mm	
	Dr116			Dr117			Dr118		62mm	
									31mm s	
									31mm s	
									93mm	
									31mm	
									93mm	
									31mm s	
155mm			186mm			217mm			155	
	Dr119			Dr120			Dr121		62mm	
	Dr122			Dr123			Dr124		31mm	
	Dr125			Dr126			Dr127		31mm	
	Dr128			Dr129			Dr130		31mm	
									62mm	
									31mm s	
									31mm s	
									31mm s	
									93mm	
									31mm	
									31mm	
									93mm	
									31mm s	
									31mm s	

You can't find what you need? Contact us and we will help you to find the solution!

"S" indicates insert profiles

## Assembling

Top & bottom profile to be used with radius side tracks and finished with frame corners.

### **Anti-theft sign.**

Easy assembly, without screws.

Ideal for personnel signs, room identification, directories, directional signs, and more...



#### APPLICATIONS

Triline® profiles  
 Vinyl lettering  
 Digital printing  
 Engraving  
 ADA  
 Braille text  
 Screen printing

#### MOUNTING POSSIBILITIES

Wall

- 1 With screw and plug.
- 2 Double tape ( At01), to be used with special cleaning product (Ac02).
- 3 Glued with Sticky Bond (Ag01)

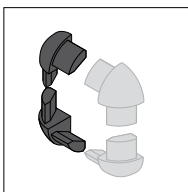

**Frame corners**  
 Standard colours

- Black
- Grey

Please contact your local distributor for other colours, prices and delivery terms.



**Top & Bottom profiles** have a standard length of 3500mm / 137.80"  
 Standard finishes

- Mill finish
- Silver anodized
- Gold anodized

Please contact your local distributor for other finishes, lengths, prices and delivery terms.

- ✓ Anti-theft
- ✓ Assembling without screws

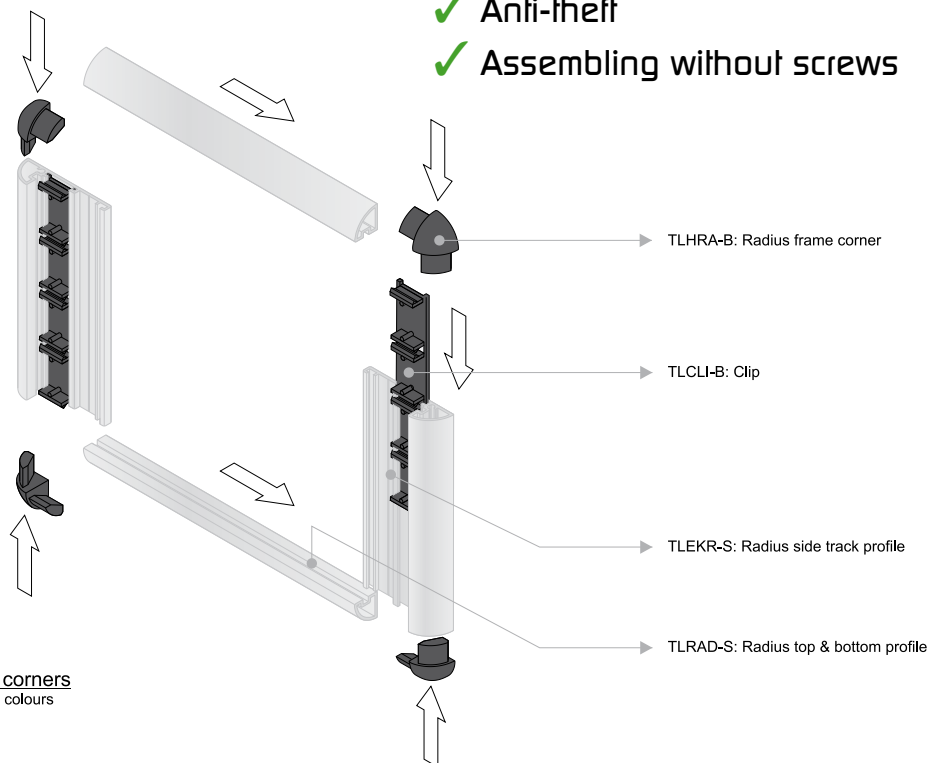

# DeSign Radius frame



RADIUS

155mm			186mm			217mm			93		
	Dr201			Dr202			Dr203		62mm		
	Dr204			Dr205			Dr206		31mm		
									62mm		
									31mm		
									62mm		
									31mm s		
155mm			186mm			217mm			124		
	Dr207			Dr208			Dr209		62mm		
	Dr210			Dr211			Dr212		31mm		
	Dr213			Dr214			Dr215		31mm		
	Dr216			Dr218			Dr218		62mm		
									31mm s		
									31mm s		
									93mm		
									31mm		
									93mm		
									31mm s		
155mm			186mm			217mm			155		
	Dr219			Dr220			Dr221		62mm		
	Dr222			Dr223			Dr224		31mm		
	Dr225			Dr227			Dr227		31mm		
	Dr228			Dr229			Dr230		31mm		
									31mm		
									62mm		
									31mm s		
									31mm s		
									31mm s		
									93mm		
									31mm		
									31mm		
									93mm		
									31mm s		
									31mm s		

This is only a selection of the endless combination possibilities that the Triline® system offers. See page 17 for more options.

"S" indicates insert profiles

## Assembling

The aluminium profiles (face and/or insert) will be snapped on the clips which have previously been integrated in the side tracks, and finished with side track caps. **Anti-theft solution:** synthetic blocking pin that slides between clips. Ideal for personnel signs, room identification, directional signs, and more...



**INSERTS**  
Triline® profiles  
The insert profiles offer the possibility to insert any kind of material with a thickness up to 1.75mm / 0.069".

**MOUNTING POSSIBILITIES**  
Wall  
**1** With screw and plug.  
**2** Double tape (At01), to be used with special cleaning product (Ac02).  
**3** Glued with Sticky Bond (Ag01)

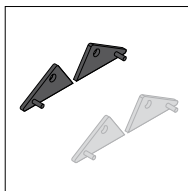

**Side track caps**  
Standard colours

- Black
- Grey

Please contact your local distributor for other colours, prices and delivery terms.



**Side track profiles** have a standard length of 3500mm / 137.80"  
Standard finishes

- Mill finish
- Silver anodized
- Gold anodized

Please contact your local distributor for other finishes, lengths, prices and delivery terms.

✓ **Anti-theft**

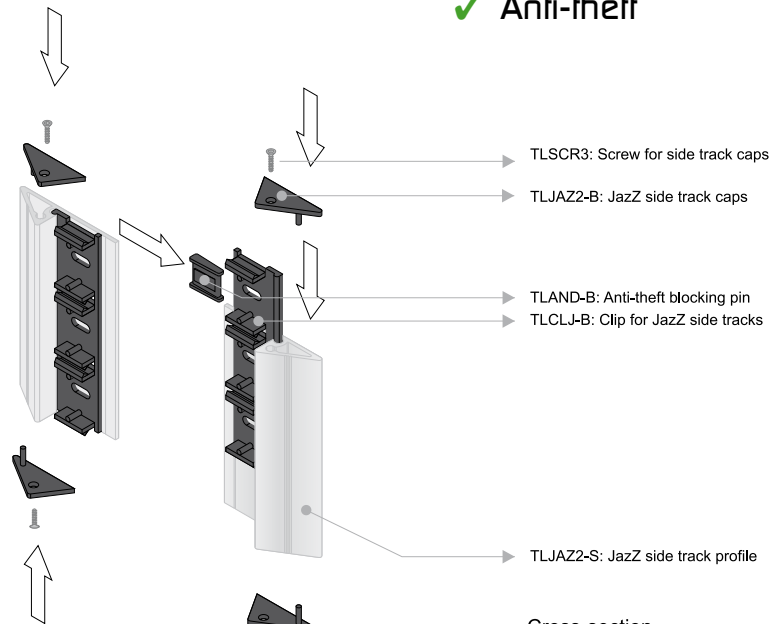

**Cross-section JazZ side tracks**

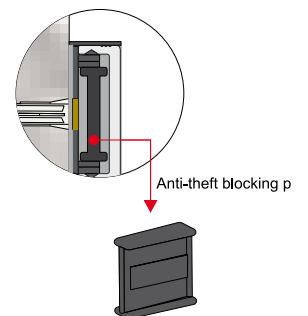





155mm			186mm			217mm			93		
	Dt101			Dt102			Dt103		62mm		
									31mm		
	Dt104			Dt105			Dt106		62mm		
									31mm s		
155mm			186mm			217mm			124		
	Dt107			Dt108			Dt109		62mm		
									31mm		
									31mm		
	Dt110			Dt111			Dt112		62mm		
									31mm s		
									31mm s		
	Dt113			Dt114			Dt115		93mm		
									31mm		
	Dt116			Dt117			Dt118		93mm		
									31mm s		
155mm			186mm			217mm			155		
	Dt119			Dt120			Dt121		62mm		
									31mm		
									31mm		
									31mm		
	Dt122			Dt123			Dt124		62mm		
									31mm s		
									31mm s		
									31mm s		
	Dt125			Dt126			Dt127		93mm		
									31mm		
									31mm		
	Dt128			Dt129			Dt130		93mm		
									31mm s		
									31mm s		

You can't find what you need? Contact us and we will help you to find the solution!

"S" indicates insert profiles

## Classic side tracks

248

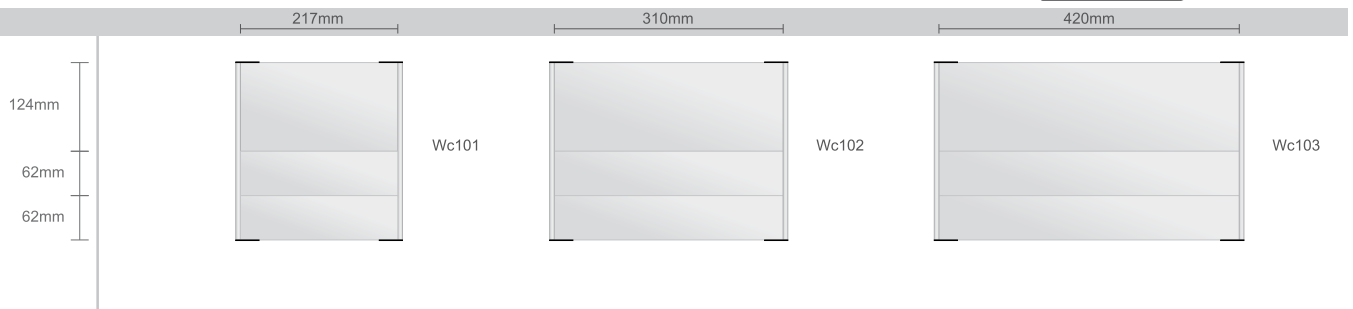

## Radius side tracks

248

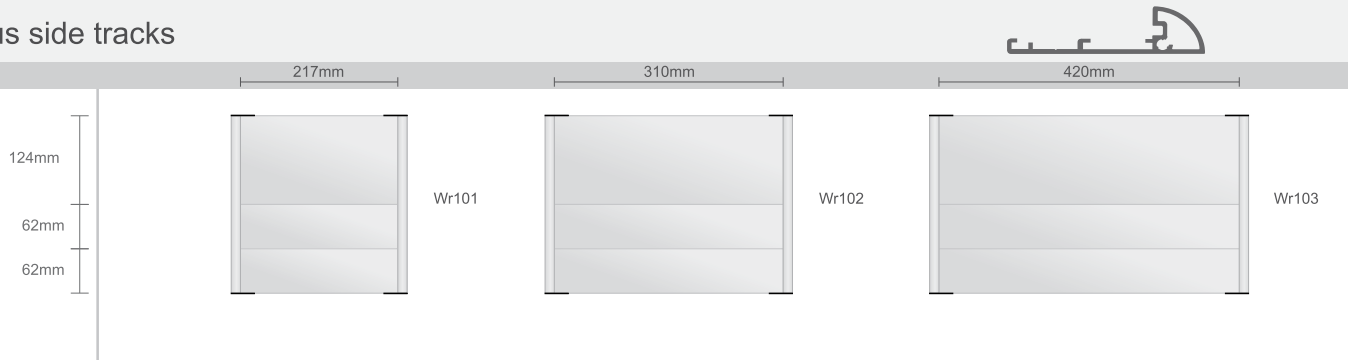

## Triangle side tracks

248

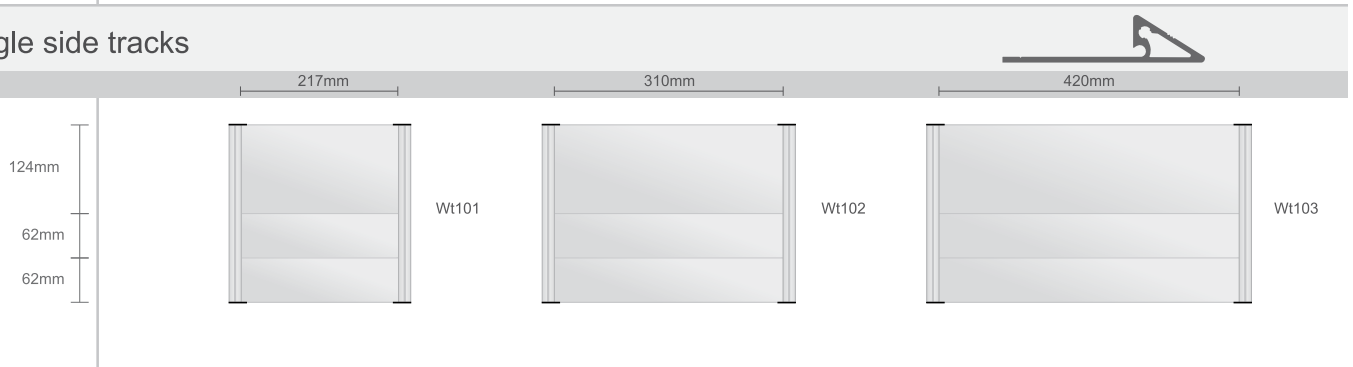

## Classic frame

248

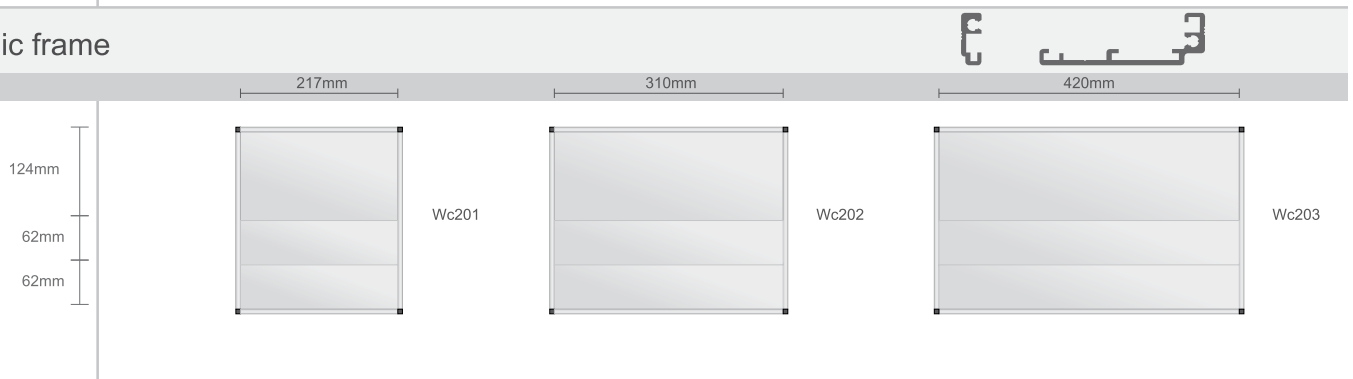





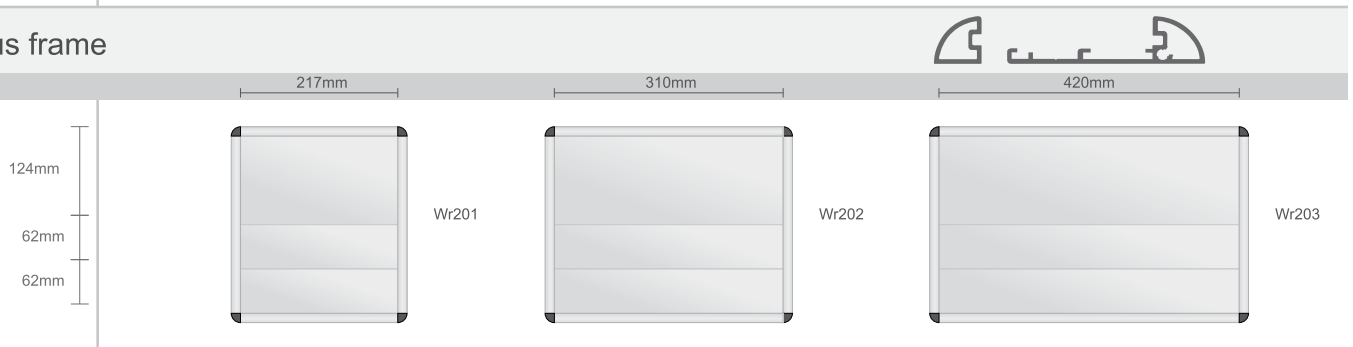





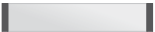
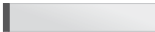
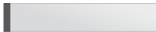









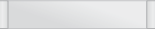
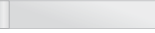
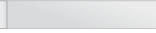

## Radius frame

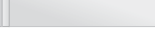
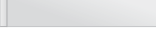
248

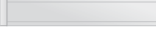

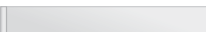
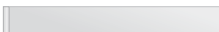
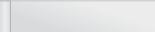
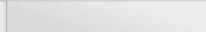
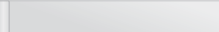
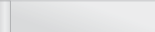
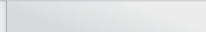
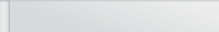
This is only a selection of the endless combination possibilities that the Triline® system offers.

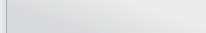
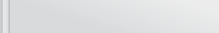
# Extra profiles to extend your signs

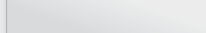
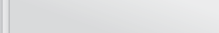
155mm	186mm	217mm	
 Ex101	 Ex102	 Ex103	<b>Synthetic</b> 31mm
 Ex104	 Ex105	 Ex106	
155mm	186mm	217mm	
 Ex107	 Ex108	 Ex109	<b>Classic</b> 31mm
 Ex110	 Ex111	 Ex112	
155mm	186mm	217mm	
 Ex113	 Ex114	 Ex115	<b>Radius</b> 31mm
 Ex116	 Ex117	 Ex118	
155mm	186mm	217mm	
 Ex119	 Ex120	 Ex121	<b>Triangle</b> 31mm
 Ex122	 Ex123	 Ex124	
217mm	310mm	420mm	
 Ex125	 Ex126	 Ex127	<b>Classic</b> 62mm
 Ex128	 Ex129	 Ex130	
217mm	310mm	420mm	
 Ex128	 Ex129	 Ex130	<b>Radius</b> 62mm
 Ex131	 Ex132	 Ex133	
217mm	310mm	420mm	
 Ex131	 Ex132	 Ex133	<b>Triangle</b> 62mm

**Note:** These extra profiles can be used to extend the door or wall sign examples showed on the previous pages.

**For example:** You need a wall sign of 420mm length in a classic frame, but instead of 2x62mm profiles you want a wall sign with 4x62mm profiles.

**Your order:** 1x (Wc203 + (Ex127 x2)) =  
A wall sign with one top profile of 124mm and four 62mm profiles in a classic frame with a length of 420mm

You can't find what you need? Contact us and we will help you to find the solution!

"S" indicates insert profiles

Assembling

Double synthetic end caps (from 62mm to 248mm),  
**Anti-theft solution:** synthetic blocking pin that slides in the profiles and in the end caps.  
 Ideal for room- level identification, emergency signage and more...

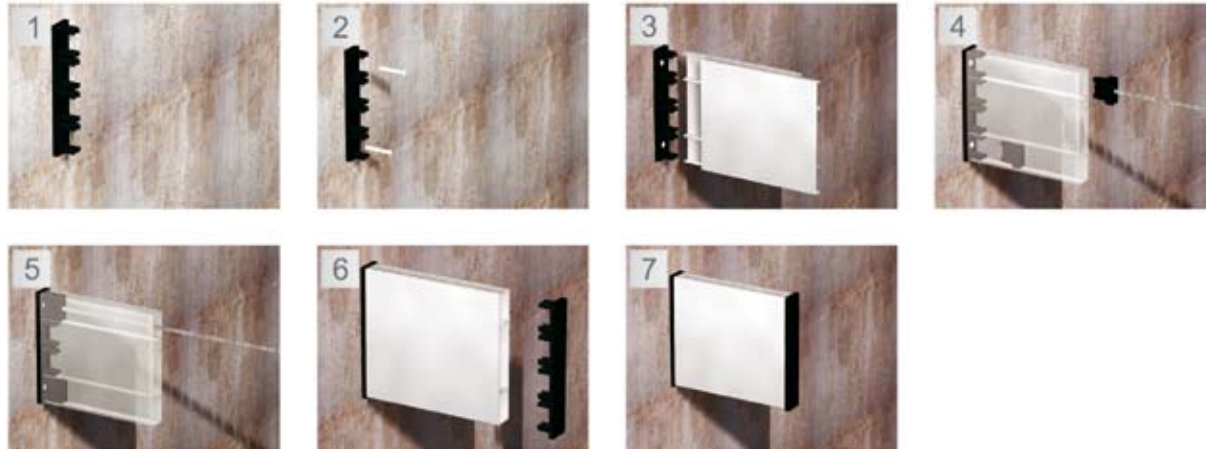

- ✓ Anti-theft
- ✓ Assembling without screws

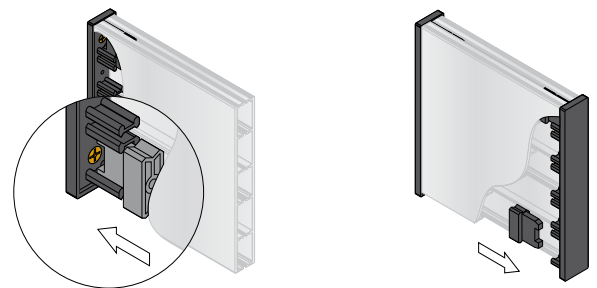

APPLICATIONS
Triline® profiles
Vinyl lettering
Digital printing
Engraving
ADA
Braille text
Screen printing

MOUNTING POSSIBILITIES
Transverse
<b>1</b> With screw and plug.

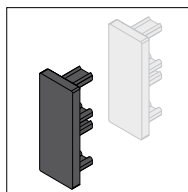

Double sided end caps  
 Standard colours

- Black
- Grey

Please contact your local distributor for other colours, prices and delivery terms.



Profiles have a standard length of 3500mm / 137.80"  
 Standard finishes

- Mill finish
- Silver anodized
- Gold anodized

Please contact your local distributor for other finishes, lengths, prices and delivery terms.

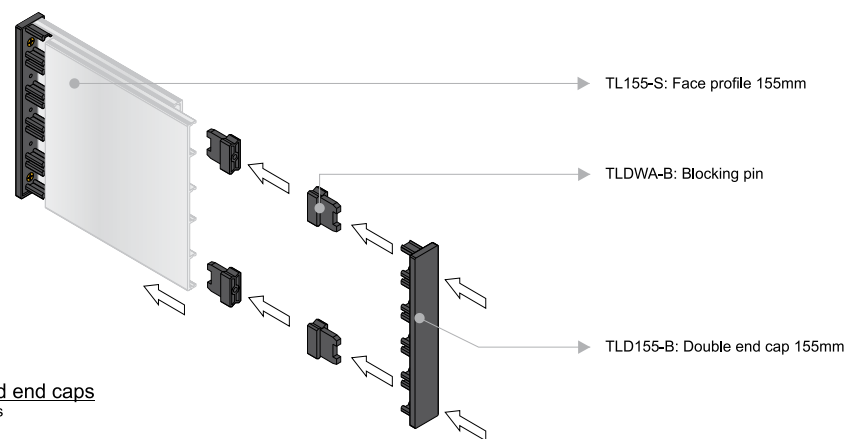



# Double sided with synthetic end caps

124mm				155mm				186mm				62	62mm				
Fs101				Fs102				Fs103									
Fs104				Fs105				Fs106				93	62mm s				
93mm				155mm				186mm									
Fs107				Fs108				Fs109				93mm	93mm s				
Fs110				Fs111				Fs112									
124mm				155mm				186mm				248mm				124	62mm
Fs113				Fs114				Fs115				Fs116					
155mm				155mm				186mm				310mm				155	31mm s
Fs117				Fs118				Fs119				Fs120					
Fs121				Fs122				31mm				93mm				186	31mm s
155mm				186mm				186mm				31mm					
Fs123				Fs124				Fs125				31mm				93mm	31mm s
Fs126				Fs127				31mm s				31mm					
155mm				186mm				217mm				217	93mm				
Fs128				Fs129				Fs130									
31mm s				31mm s				31mm s				31mm					

You can't find what you need? Contact us and we will help you to find the solution!

"S" indicates insert profiles

## Assembling

Double synthetic end caps (from 62mm to 248mm), suspension system "inox look".  
 Double retaining clip for hanging several profiles one underneath the other.  
 Suspended sign with alluminium conection pieces, to guarantee safety in case of fire.  
**Anti-theft solution:** synthetic blocking pin that slides in the profiles, into the end cap.  
 Ideal for personnel signs, directional signs, emergency signage and more...

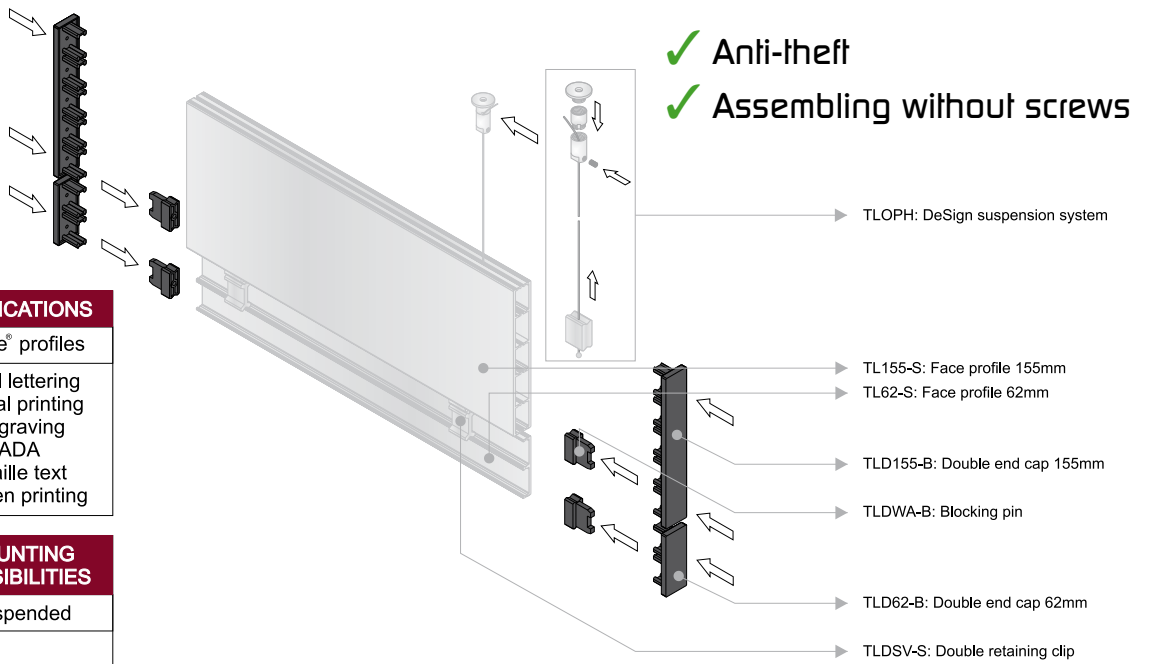
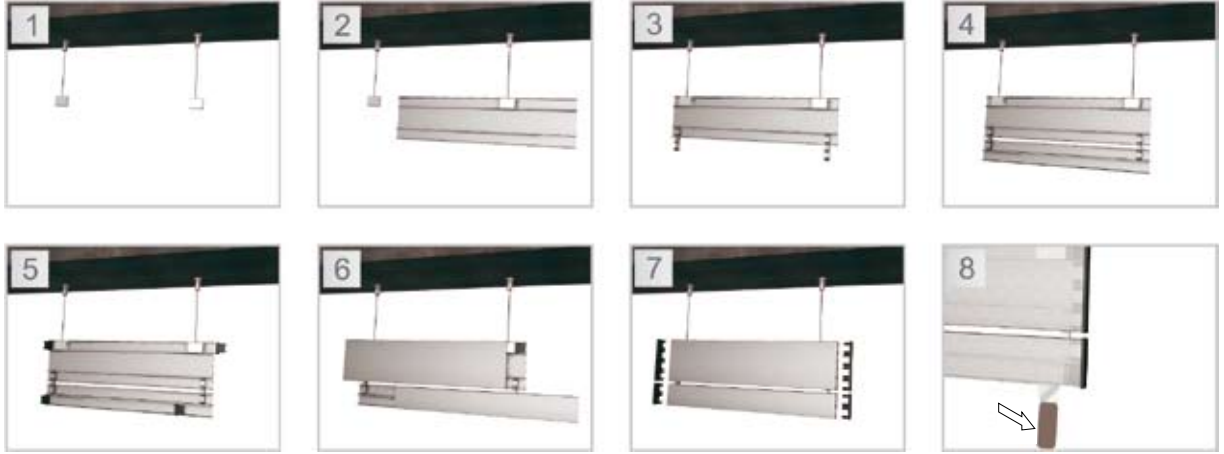

### APPLICATIONS

- Triline® profiles
- Vinyl lettering
- Digital printing
- Engraving
- ADA
- Braille text
- Screen printing

### MOUNTING POSSIBILITIES

Suspended

1

With screw and plug.

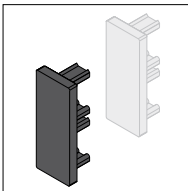

### Double sided end caps

Standard colours

- Black
- Grey

Please contact your local distributor for other colours, prices and delivery terms.

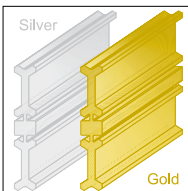

### Profiles

have a standard length of 3500mm / 137.80"  
 Standard finishes

- Mill finish
- Silver anodized
- Gold anodized

Please contact your local distributor for other finishes, lengths, prices and delivery terms.

### Cross-section

Suspension system

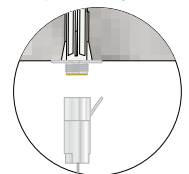

# Double sided with synthetic end caps



This is only a selection of the endless combination possibilities that the Triline® system offers.

## Assembling

Two extra profiles, to be used with classic and radius side tracks:

- Intermediate profile, to subdivide your directory.
- Support profile (invisible), to support the directory sign.

**Anti-theft solution:** synthetic blocking pin that slides between clips.

Ideal for: directories made to measure, customer requests and more...

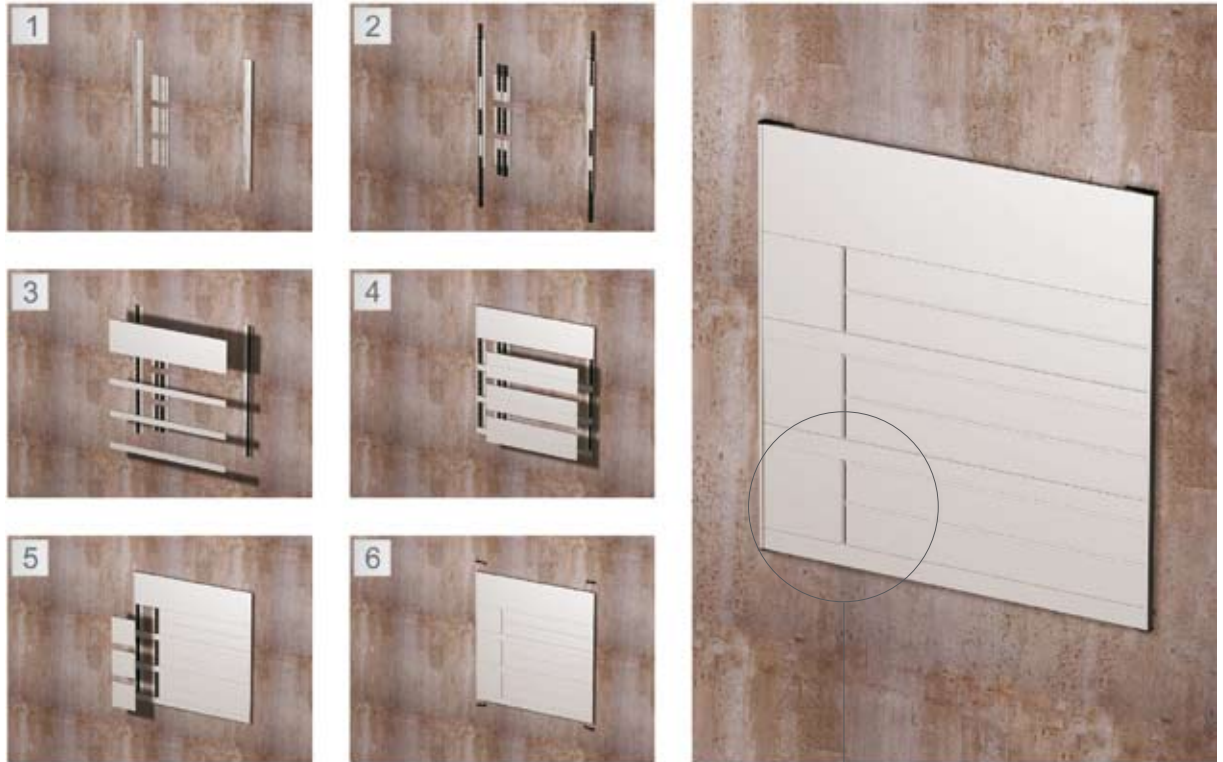

Classic



Classic frame



Radius



Radius frame

### MOUNTING POSSIBILITIES

#### Wall

- 1 With screw and plug.
- 2 Double tape ( At01), to be used with special cleaning product (Ac02).
- 3 Glued with Sticky Bond (Ag01)

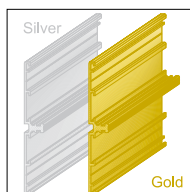

Profiles have a standard length of 3500mm / 137.80"  
Standard finishes

- Mill finish
- Silver anodized
- Gold anodized

Please contact your local distributor for other finishes, lengths, prices and delivery terms.

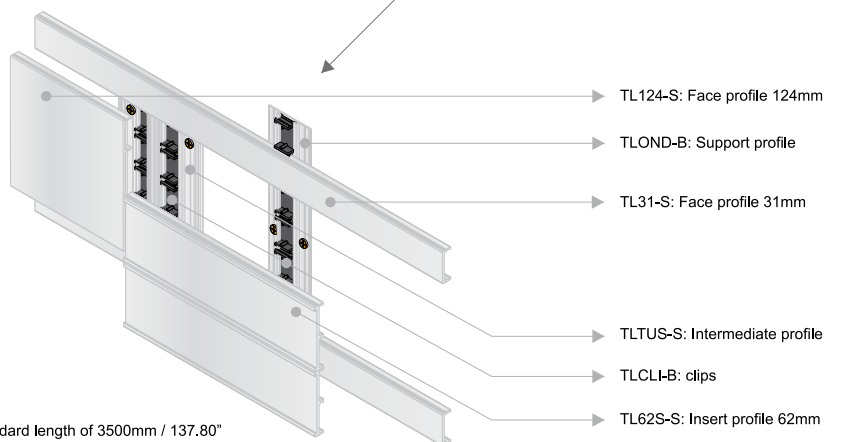

### Triline® KEY

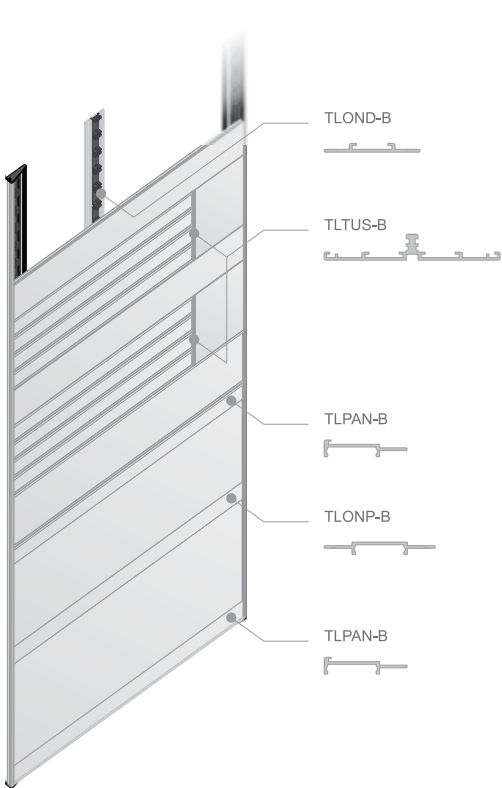

**Note:**  
The Triline® key cannot remove profiles which have been locked with the TLAND-B blocking pin!

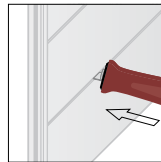

**1** The Triline key needs to be slid horizontally between the profiles, at minimum 50mm distance from the side tracks.

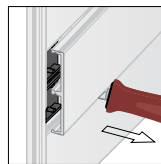

**2** Pull the key backwards, the profile is now released from the clips and can be removed from the sign.



Triline® the modular system made for the creative mind!



# Design



## Classic side tracks

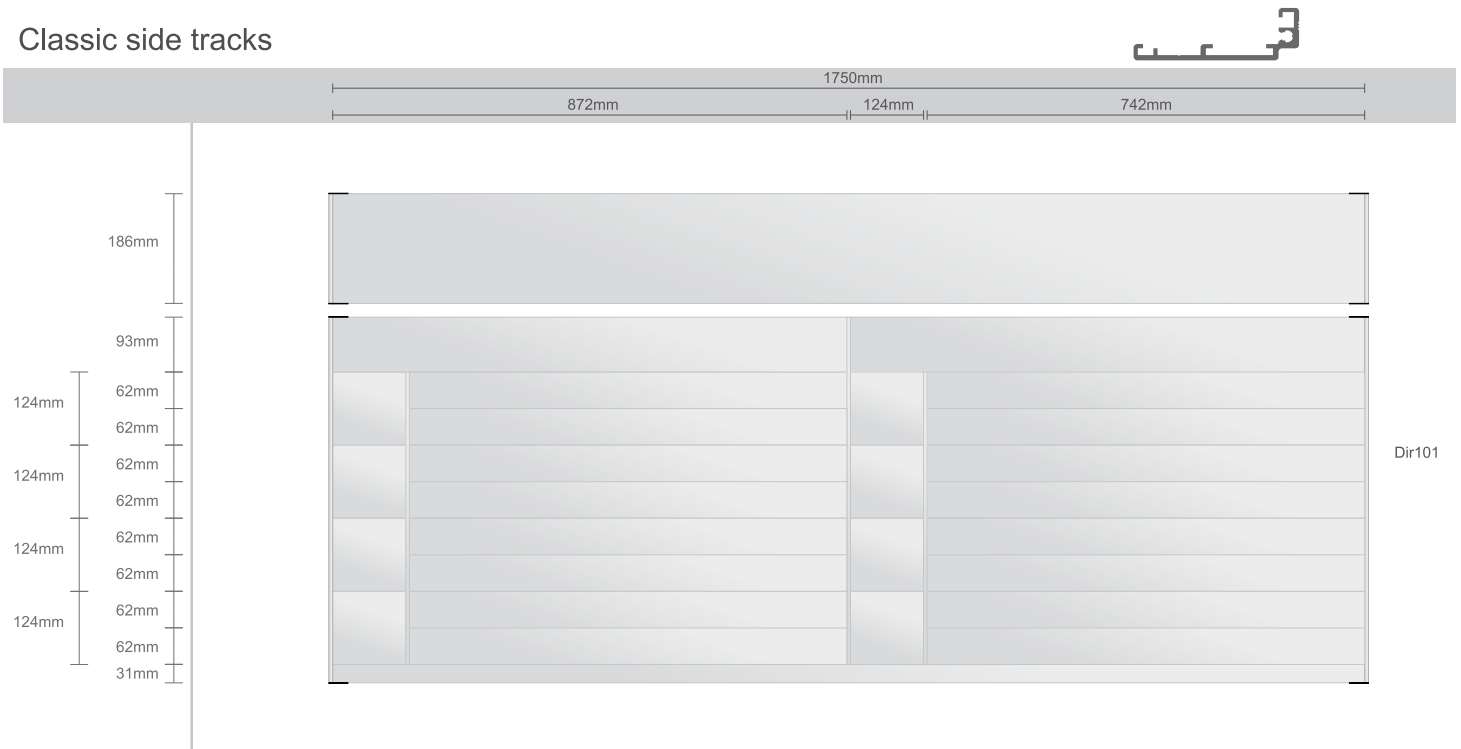

## Classic frame

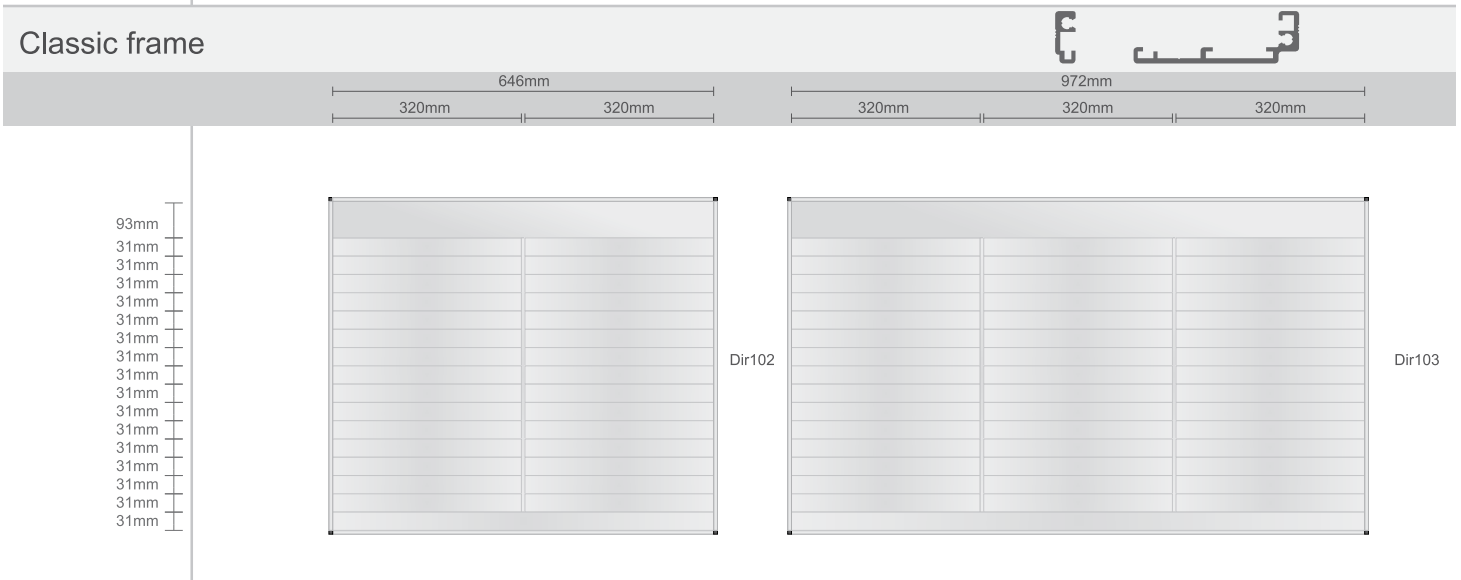

## Radius frames

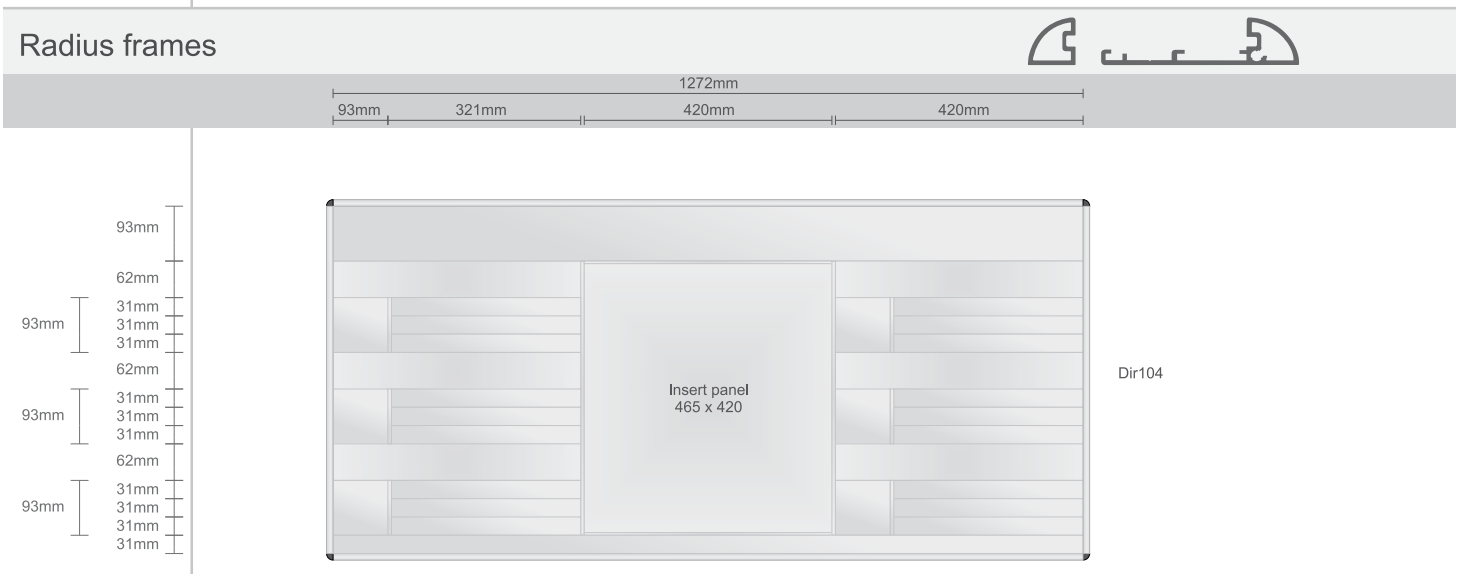



## Radius side tracks

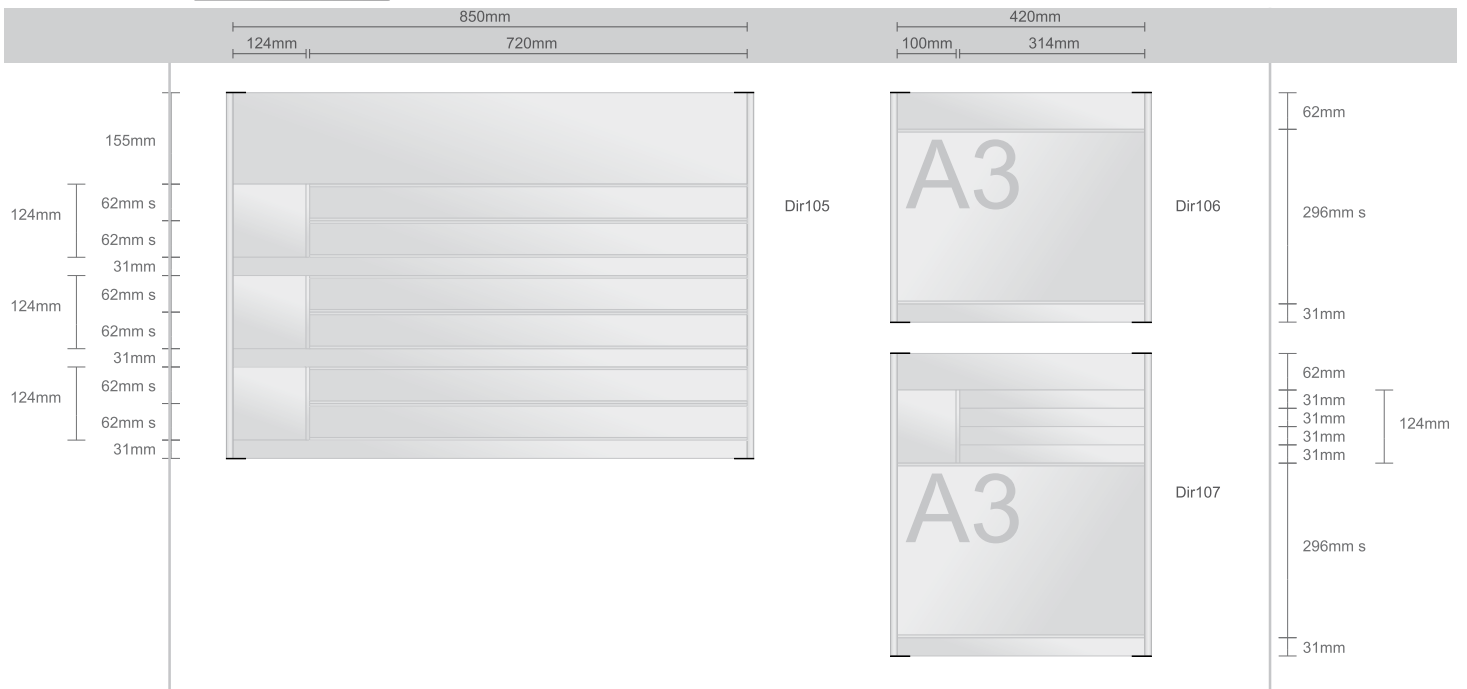

## Classic side tracks

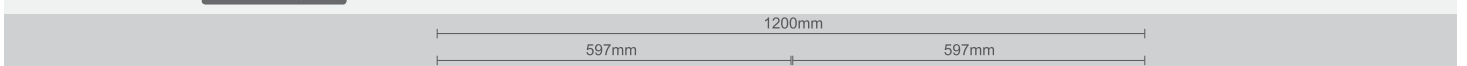

### MOUNTING POSSIBILITIES

Wall

- 1** With screw and plug.
- 2** Double tape (At01), to be used with special cleaning product (Ac02).
- 3** Glued with Sticky Bond (Ag01)

### APPLICATIONS

Triline® profiles

Vinyl lettering  
Digital printing  
Engraving, ADA  
Braille text  
Screen printing

### INSERTS

Triline® profiles

The insert profiles offer the possibility to insert any kind of material with a thickness up to 1.75mm / 0.069"

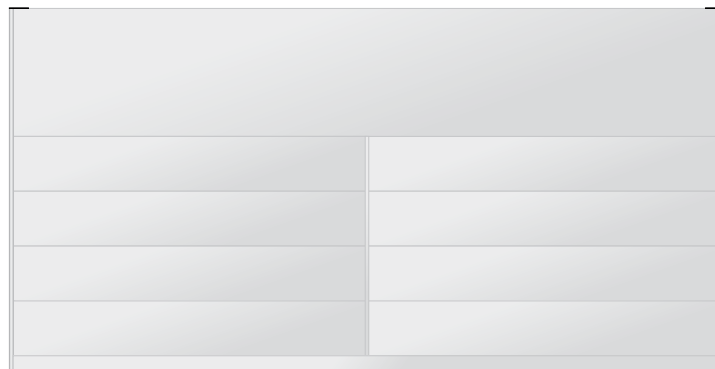

Dir108

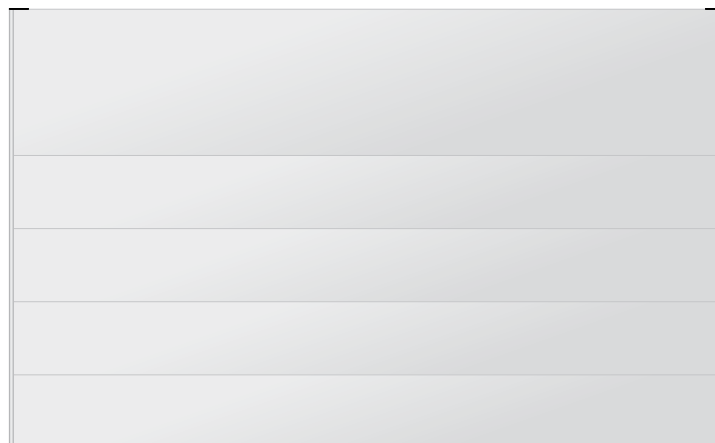

Dir109

You can't find what you need? Contact us and we will help you to find the solution!

"S" indicates insert profiles

Assembling

Two standard sizes 31mm and 62mm to be used with synthetic blocking pin that slides in the end caps for desk stand.  
 The aluminum profiles (face and/or insert) will slide in the end caps.  
 Easy assembly.  
 Ideal for desk information, job description and name tags.

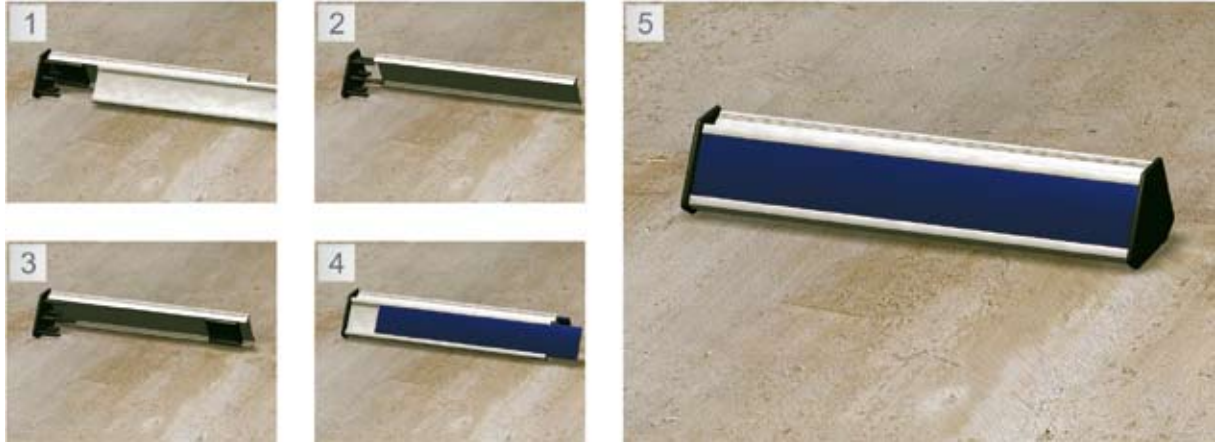

INSERTS
Triline® profiles
The insert profiles offer the possibility to insert any kind of material with a thickness up to 1.75mm / 0.069".

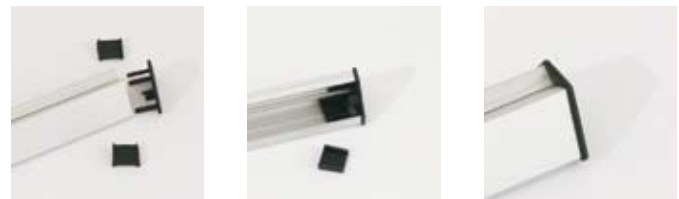

✓ Easy assembly

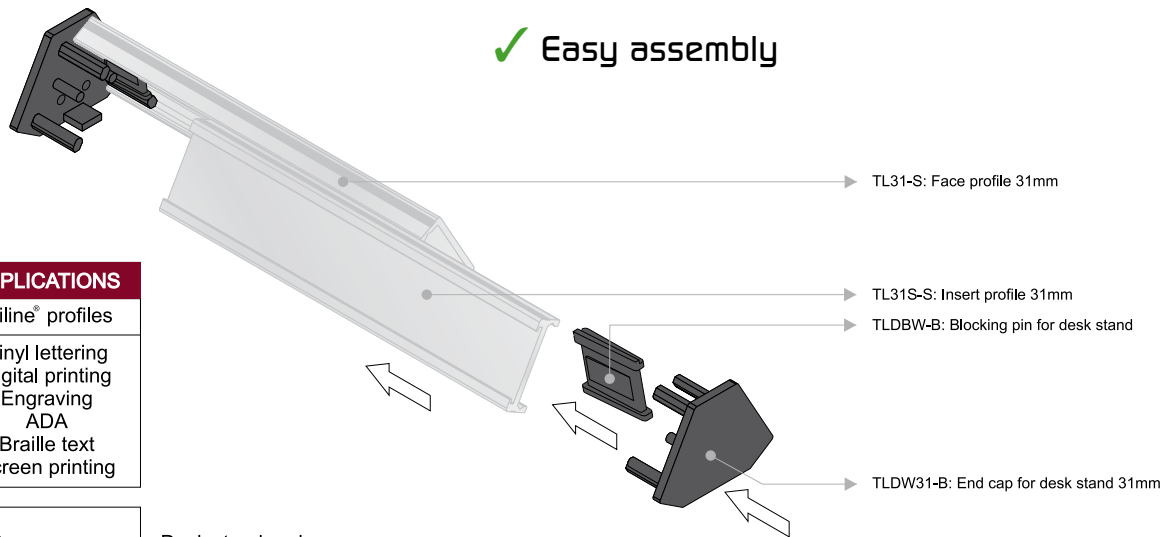

APPLICATIONS
Triline® profiles
Vinyl lettering
Digital printing
Engraving
ADA
Braille text
Screen printing

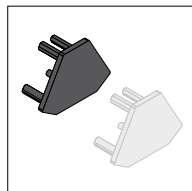

**Desk stand end caps**  
 Standard colours

- Black
- Grey

Please contact your local distributor for other colours, prices and delivery terms.



**Profiles** have a standard length of 3500mm / 137.80"  
 Standard finishes

- Mill finish
- Silver anodized
- Gold anodized

Please contact your local distributor for other finishes, lengths, prices and delivery terms.

# Desk stands – Samples

155mm			180mm			31
Front & Back		D101	Front & Back		D104	
Front & Back		D102	Front & Back		D105	31mm s
Front		D103	Front		D106	31mm
Back			Back			31mm s

180mm			250mm			62
Front & Back		D107	Front & Back		D113	
Front & Back		D108	Front & Back		D114	62mm
Front		D109	Front		D115	62mm
Back			Back			31mm s 31mm s
Front		D110	Front		D116	62mm
Back			Back			31mm 31mm
Front		D111	Front		D117	62mm
Back			Back			31mm s 31mm s
Front		D112	Front		D118	62mm
Back			Back			31mm 31mm s



This is only a selection of the endless combination possibilities that the Triline® system offers.

"S" indicates insert profiles

Assembling

Standard A4 insert profile and two variable insert profiles adaptable to any size.

A4: with **anti-vandalism synthetic end caps**.

A4 and A3: with side tracks and frames.

**Anti-theft solution:** synthetic blocking pin that slides between clips.

Ideal for evacuation plans, room- level information and more...



Six different styles



Synthetic (only A4)



Classic



Classic frame



Radius



Radius frame



Triangle

MOUNTING POSSIBILITIES	
Wall	
1	With screw and plug.
2	Double tape (At01), to be used with special cleaning product (Ac02).
3	Glued with Sticky Bond (Ag01)

APPLICATIONS
Triline® profiles
Vinyl lettering
Digital printing
Engraving, ADA
Braille text
Screen printing

INSERTS
Triline® profiles
The insert profiles offer the possibility to insert any kind of material with a thickness up to 1.75mm / 0.069"

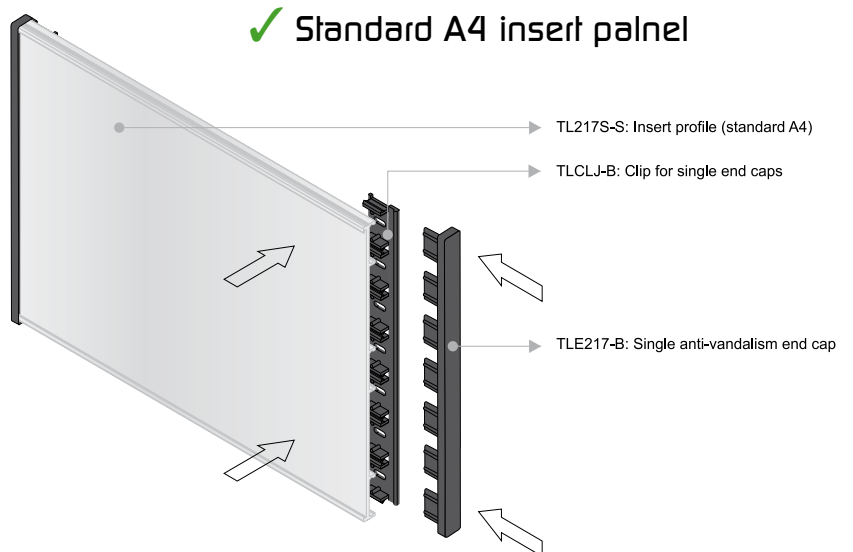



✓ Insert panels made to measure

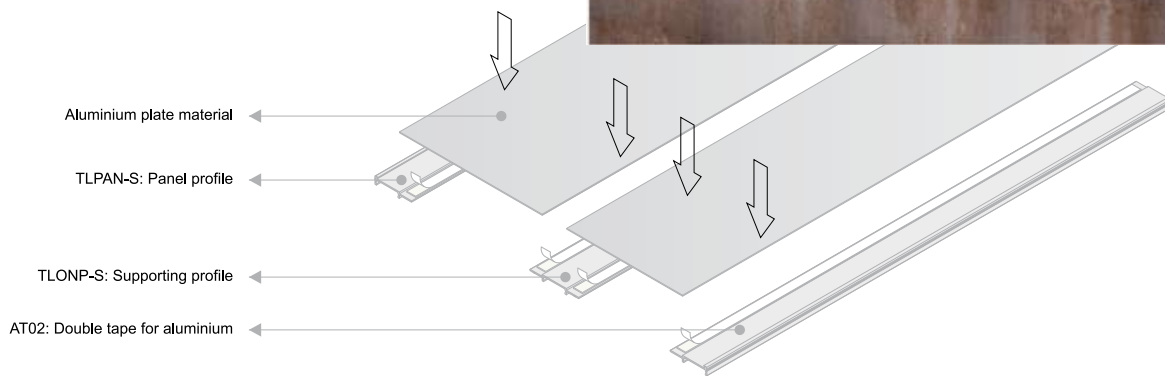

296mm						A4
Synthetic	Classic	Radius	Triangle	Classic frame	Radius frame	217mm s
Din101	Din102	Din103	Din104	Din105	Din106	
420mm					A3	296mm s
Classic	Radius	Triangle	Classic frame	Radius frame		
Din107	Din108	Din109	Din110	Din111		

You can't find what you need? Contact us and we will help you to find the solution!

"S" indicates insert profiles



## Wall

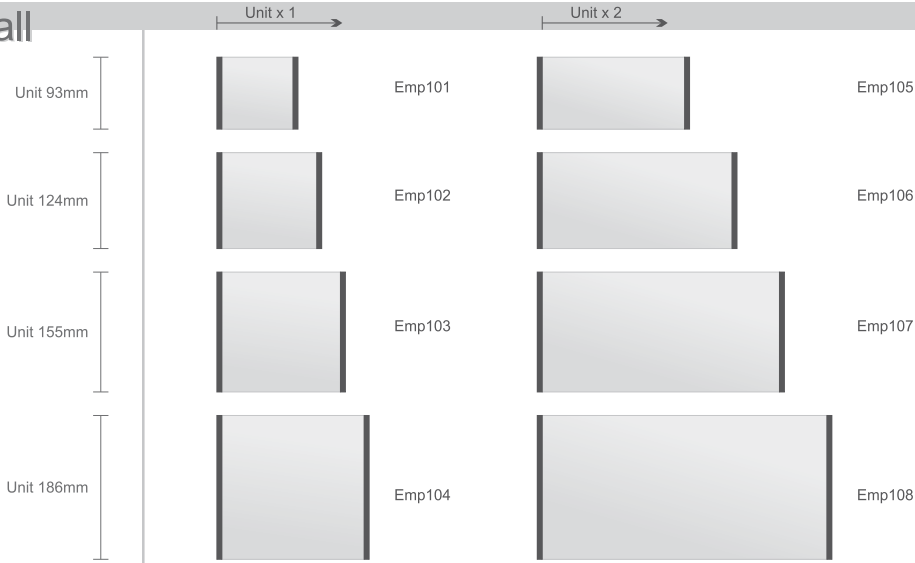

## Transverse

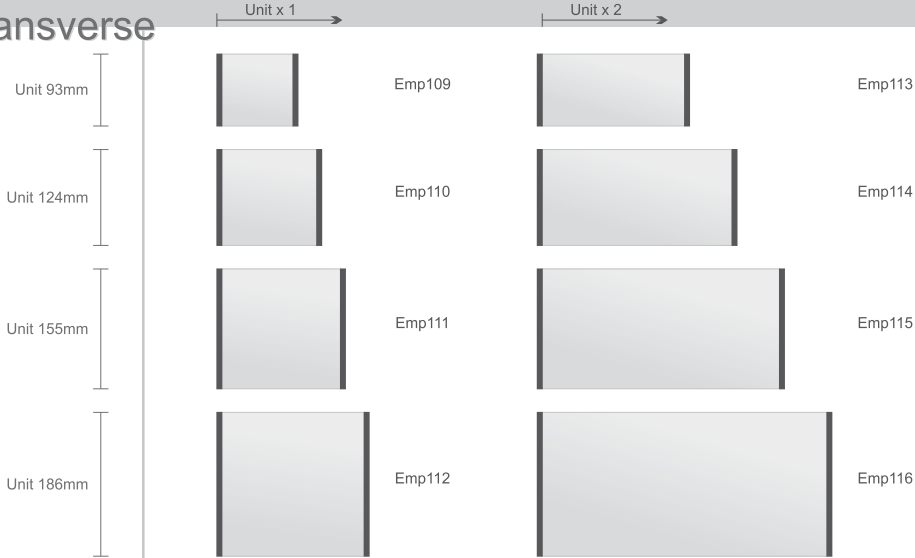

## Suspension

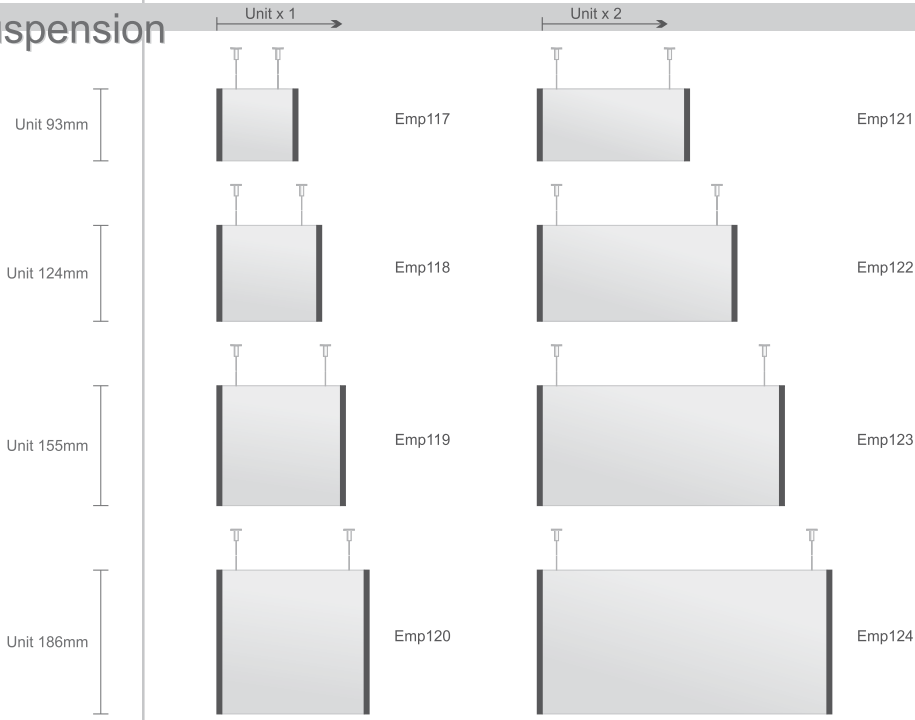

This is only a selection of the endless combination possibilities that the Triline® system offers.





A series of horizontal dotted lines for writing, starting below the first dotted line and ending above the footer.



