

Alliance

 **ALUE**
VISUAL ALUMINIUM EXCELLENCE

GUIDEBOOK SEMI-FINISHED PRODUCTS

Way Finding Solutions

Features

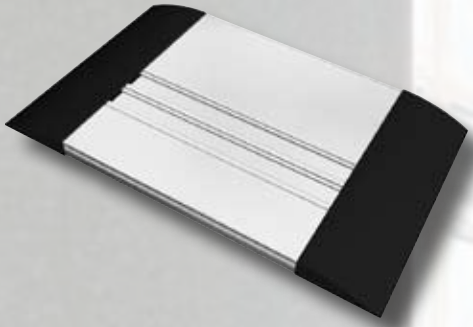

The Alliance product line is derived from DeSign but was given a more contemporary look.

Alliance emphasizes your wishes to express dynamics and spirit of enterprise.



Features

- Complete new innovative range
- Snap-on system with contemporary looks
- Modular and easily changeable
- Unique synthetic end caps in a stylish slim line or modern elliptical shape.
- 9 standard heights in face profiles
- 6 standard heights in insert profiles with among others a 15,5 mm insert profile to create a special accent in directory panels
- Possibility to create A4



Triline®



alliance

ALUE
VISUAL ALUMINIUM EXCELLENCE

	page
Aluminium profiles & Synthetic parts	2.2
Assembling	2.4
Door Signs	2.6
Wall Signs	2.10

Face profiles

The face profiles have a material thickness from 1.5mm / 0.06" up to 3mm / 0.12", allowing engraving and Braille applications.

Insert profiles

The insert profiles offer the possibility to insert any kind of material with a thickness up to 1.75mm / 0.069".

Panel & supporting profile

These variable insert profiles offer the possibility to create any type and measure of insert panels larger than A4 (for example A3, A2, A1), and to integrate for example maps in large directories.

Side track profiles

Side track profiles can be used in any application, both in small door signs and in larger overview panels.

Intermediate profile

Intermediate profiles are only to be used in combination with side track profiles:

- TLEKC
- TLEKR

Article code	width frame	Insert measures
TL15S-B	15,5mm / 0.61"	11,5mm / 0.45"
TL31-B	31mm / 1.22"	-
TL31S-B	31mm / 1.22"	23mm / 1.02"
TL46-B	46mm / 1.83"	-
TL62-B	62mm / 2.44"	-
TL62S-B	62mm / 2.44"	57mm / 2.24"
TL93-B	93mm / 3.66"	-
TL93S-B	93mm / 3.66"	88mm / 3.46"
TL124-B	124mm / 4.88"	-
TL155-B	155mm / 6.1"	-
TL155S-B	155mm / 6.1"	149,4mm / 5.88"
TL186-B	186mm / 7.3"	-
TL217-B	217mm / 8.54"	-
TL217S-B	217mm / 8.54"	212mm / 8.35"
TL248-B	248mm / 9.76"	-

Decipher the Triline® code

Face and insert profiles	Alliance end caps
TL = Triline®	TL = Triline®
31 = 31mm width profile	EE = Ellipse end cap
S = insert profile	EC = Classic end cap
-B = mill finish	93 = 93mm length end cap
-S = silver anodised	-B = black
-G = gold anodised	-G = grey

Top & bottom profiles

Top & bottom profiles are only used in combination with side track profiles.

Support profile

We recommend to install this invisible support profile (vertical), when the individual horizontal profiles are longer than 80cm / 3.15".

Aluminium profiles and synthetic parts

Ellipse end caps

Elliptical shape synthetic end caps for wall fixation. With these end caps you can combine profiles from 15.5mm/0.61" up to 217mm/8.35".

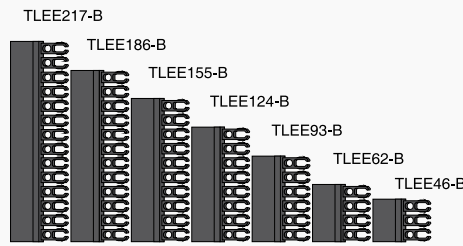

Blocking pin / side tracks

TLAND is a patented anti-theft blocking pin for securing all types of wall mounted signs assembled with side tracks.

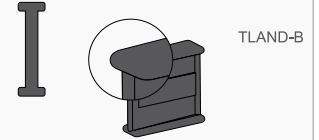

Classic end caps

Slim shape synthetic end caps for wall fixation. With these end caps you can combine profiles from 15.5mm/0.61" up to 217mm/8.35".

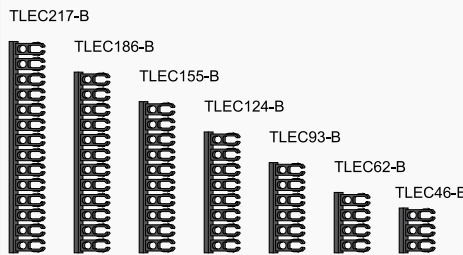

Screw

TLSCR3 is used to lock the side track caps or classic frame corners and to ensure the correct blocking of the TLCLI / TL15' clips in the side tracks.



Side track caps

Side track caps are only used in combination with side track profiles.



TLCLAS with TLEKC
TLRADS with TLEKR

Clips

TLCLI is used in combination with TLEKC and TLEKR side tracks, intermediate profile, support profile. These clips guarantee an extensive flexibility, without breaking. TLCLI15 is used to assemble the profiles: TL15S, TL46 onto TLEKC and TLEKR.

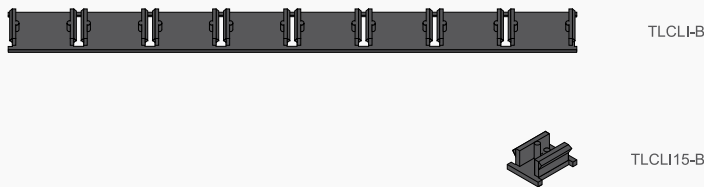

Frame corners

These are only used in combination with side track profiles and top & bottom profiles

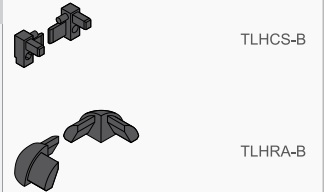

TLHCS with TLEKC, TLCLAT
TLHRA with TLEKR, TLRAD

Key

TLKEY is created to unlock the profiles from their clips and replace a profile in a sign without disassembling the signs.

The key has a stainless steel insert piece with a synthetic handle.



TriLine® KEY

Note:
The TriLine® key cannot remove profiles which have been locked with the TLAND-B blocking pin!

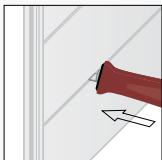

1 The TriLine key needs to be slid horizontally between the profiles, at minimum 50mm distance from the side tracks.

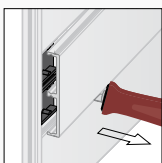

2 Pull the key backwards, the profile is now released from the clips and can be removed from the sign.

Alliance

Assembling
Signs
with ellipse
and classic
synthetic
end caps

Two special profiles, 15.5mm insert and 46mm face profile.
Can be combined with all other profiles and the Alliance end caps (Ellipse and Classic).
End caps are available from 46.5mm to 217mm.
Easy assembly.
Ideal for personnel signs, room identification, wall projection signs, emergency and more...

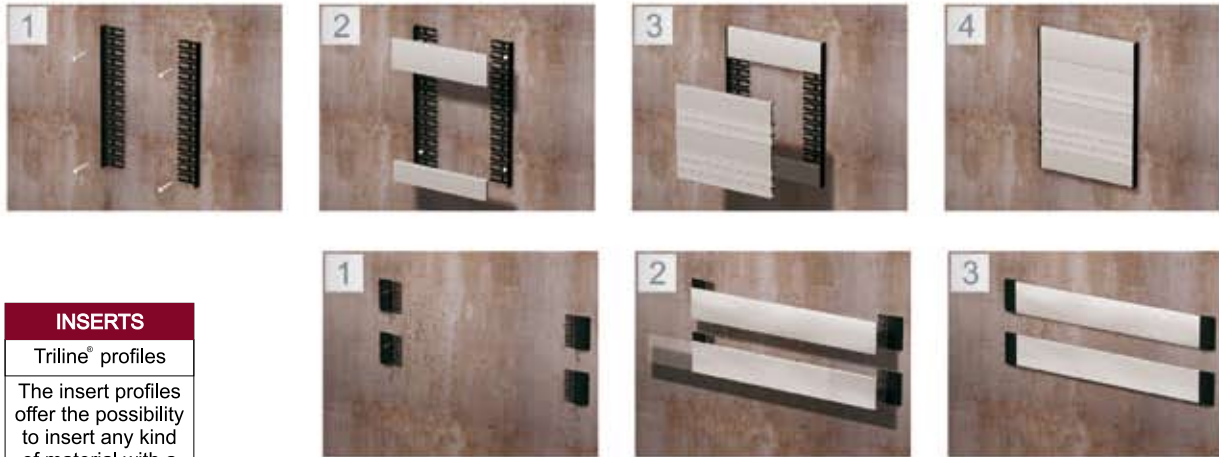

INSERTS
Triline® profiles
The insert profiles offer the possibility to insert any kind of material with a thickness up to 1.75mm / 0.069".

APPLICATIONS
Triline® profiles
Vinyl lettering
Digital printing
Engraving
ADA
Braille text
Screen printing

MOUNTING POSSIBILITIES
Wall
1 With screw and plug.
2 Double tape (At01), to be used with special cleaning product (Ac02).
3 Glued with Sticky Bond (Ag01)

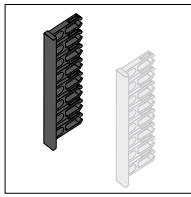

Alliance end caps
Standard colours
- Black
- Grey



Profiles have a standard length of 3500mm / 137.80"
Standard finishes
- Mill finish
- Silver anodized
- Gold anodized

Please contact your local distributor for other finishes, lengths, prices and delivery terms.

✓ Easy assembly

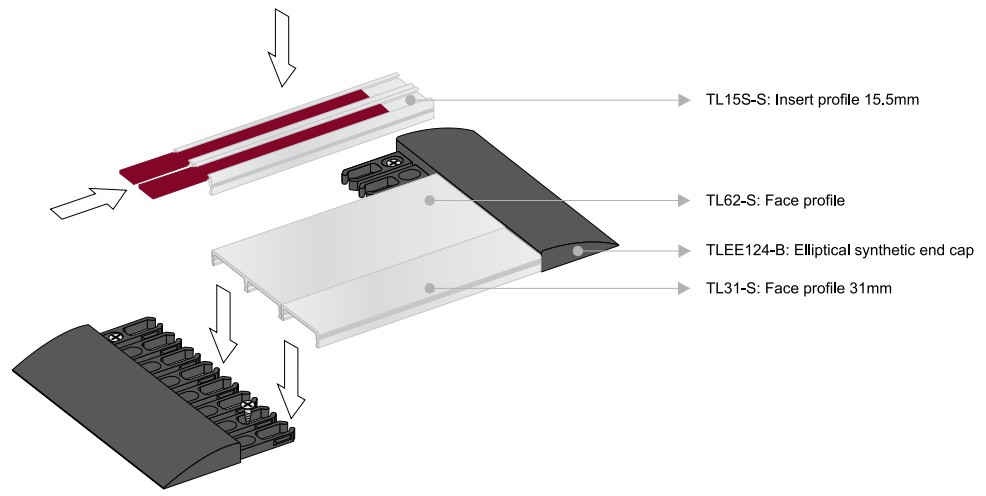

Two different end caps



The two profiles, 15.5mm insert and 46mm face profile can be combined with our side tracks and frames, using a special clip of 15.5mm. **Anti-theft solution:** synthetic blocking pin that slides between clips. Ideal for personnel signs, room identification, wall projection signs and more...

Assembling

Signs with side tracks and frames

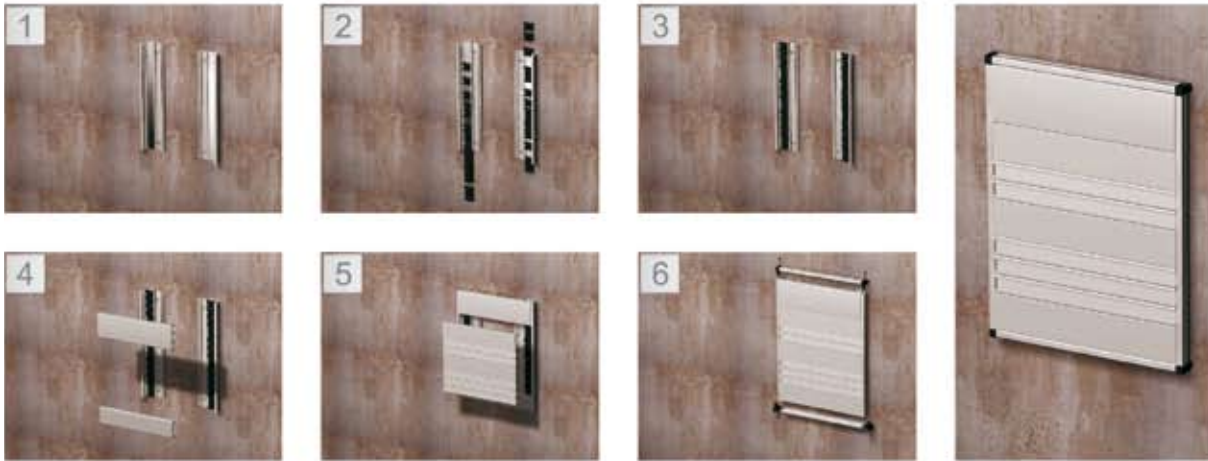

✓ Anti-theft

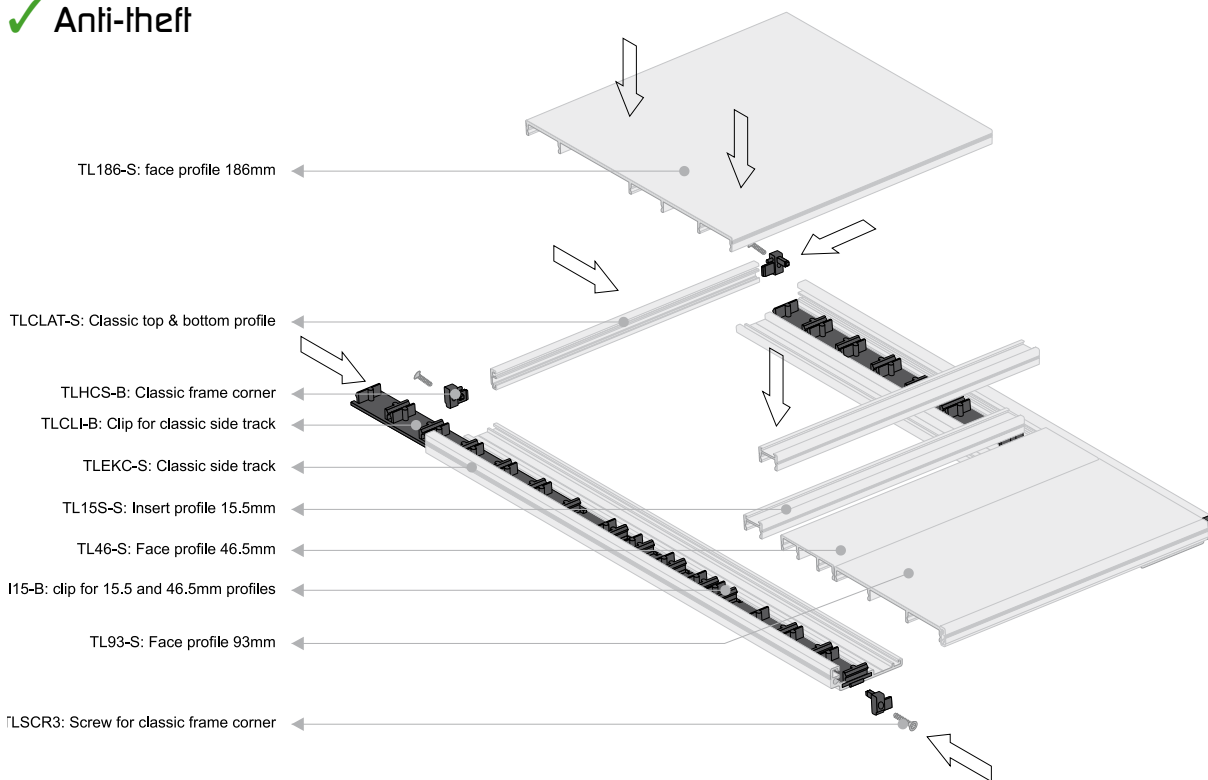



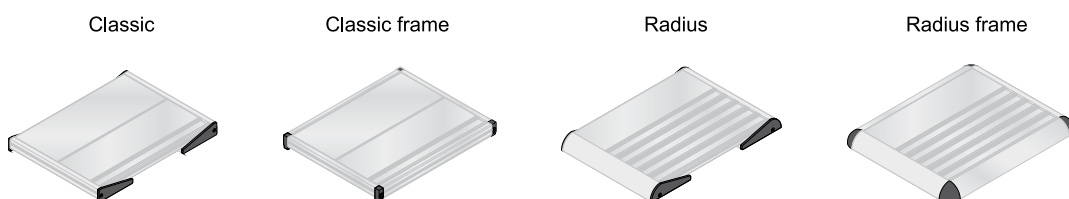



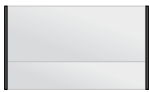
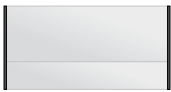
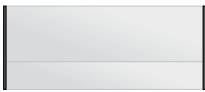
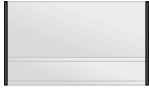
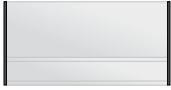
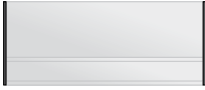
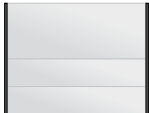
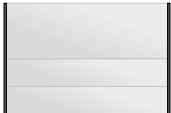
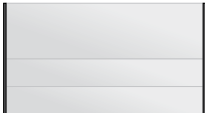
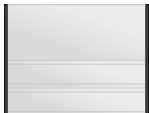
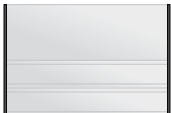
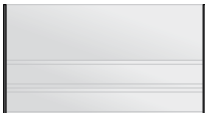
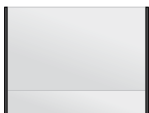
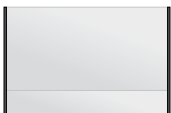
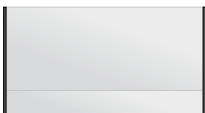
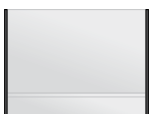
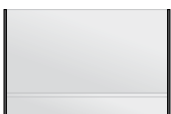
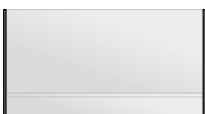

Four different styles

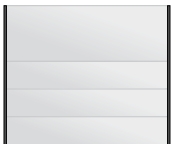
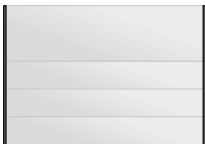

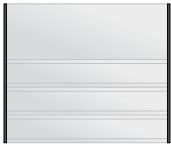
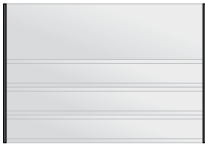
Alliance

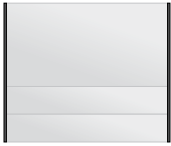
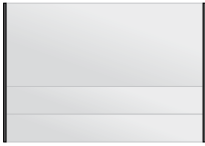
Classic end caps

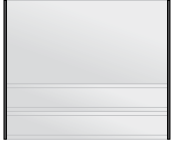
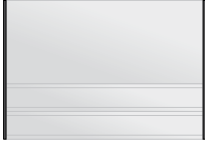
	155mm	186mm	217mm
93			
62mm 31mm	 Ac101	 Ac102	 Ac103
62mm 31mm s	 Ac104	 Ac105	 Ac106
124			
62mm 31mm 31mm	 Ac107	 Ac108	 Ac109
62mm 31mm s 31mm s	 Ac110	 Ac111	 Ac112
93mm 31mm	 Ac113	 Ac114	 Ac115
93mm 31mm s	 Ac116	 Ac117	 Ac118
155			
62mm 31mm 31mm 31mm	 Ac119	 Ac120	 Ac121
62mm 31mm s 31mm s 31mm s	 Ac122	 Ac123	 Ac124
93mm 31mm 31mm	 Ac125	 Ac126	 Ac127
93mm 31mm s 31mm s	 Ac128	 Ac129	 Ac130

"S" indicates insert profiles

You can't find what you need? Contact us and we will help you to find the solution!



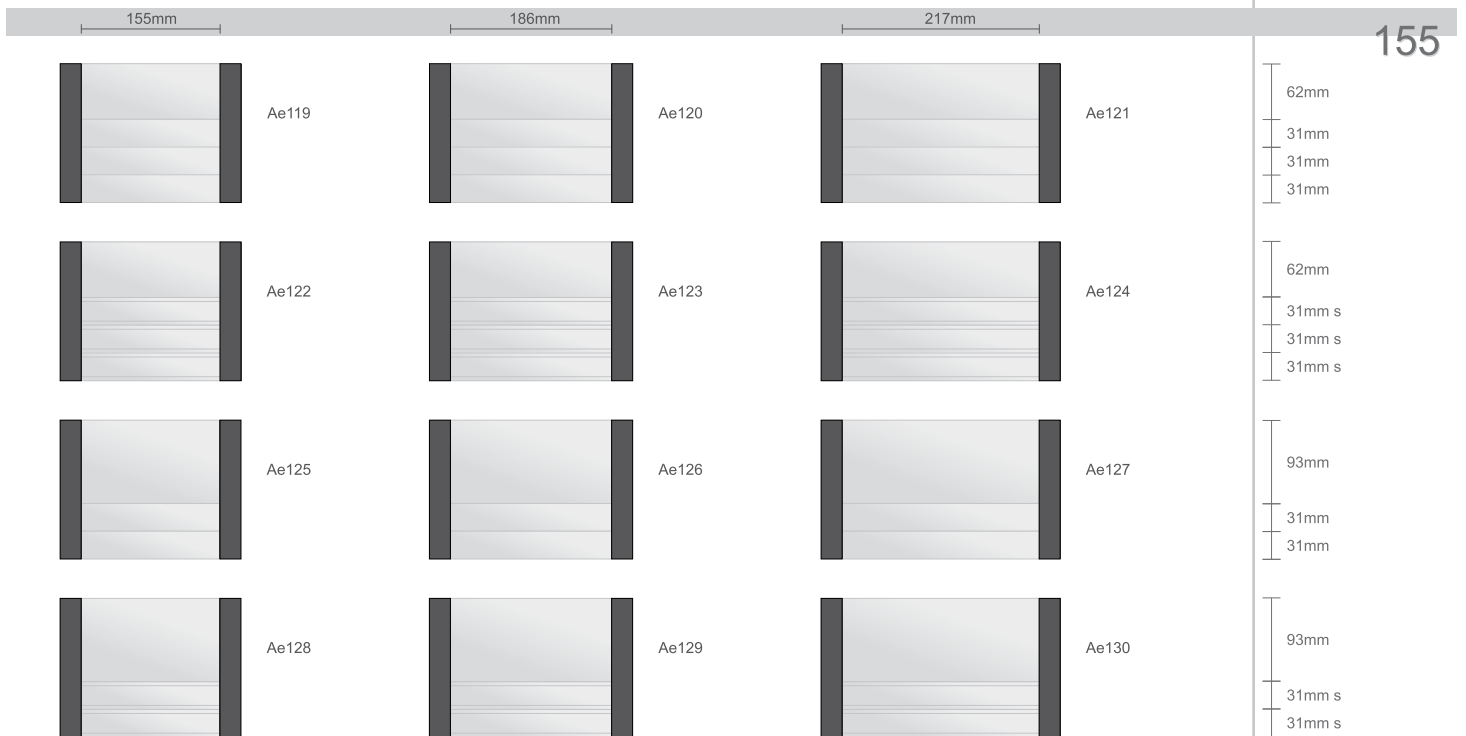
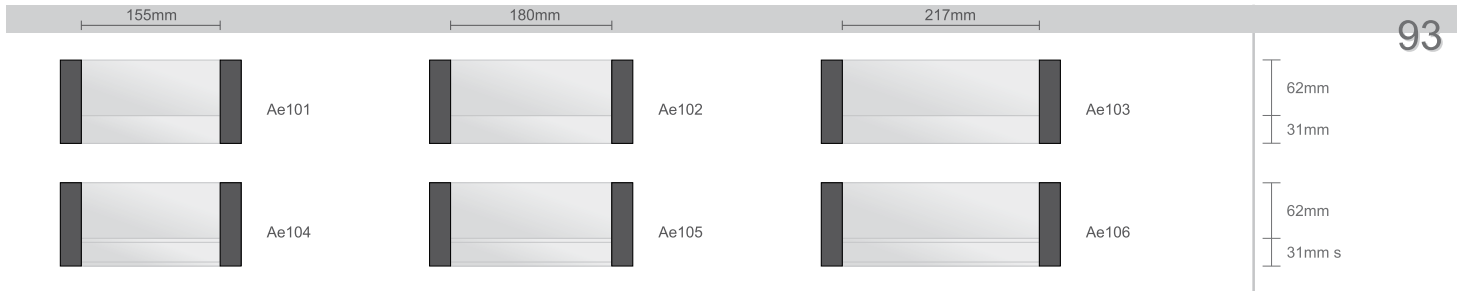





Ellipse end caps – Door Signs

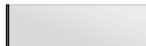
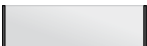
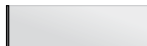
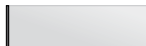
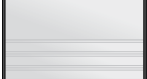
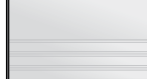
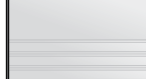
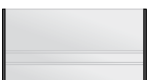
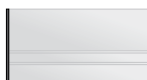
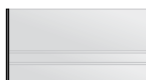
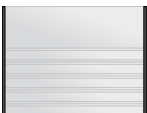
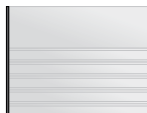
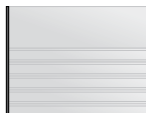

This is only a selection of the endless combination possibilities that the Triline® system offers. See page 7 & 8 for more options.

"S" indicates insert profiles

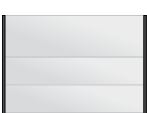
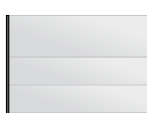
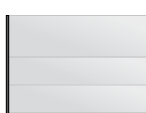
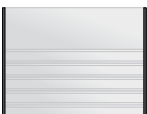
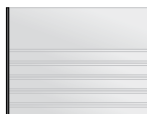
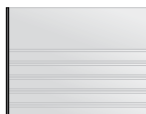
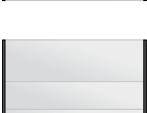
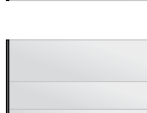
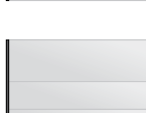
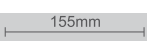
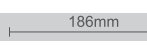
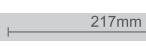
Classic end caps

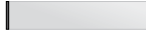
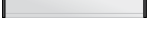
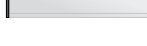
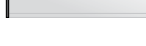
	155mm	186mm	217mm
46.5	 Ac201	 Ac210	 Ac219
46,5mm			
62	 Ac202	 Ac211	 Ac220
46,5mm 15,5 s mm			
93	 Ac203	 Ac212	 Ac221
46,5mm 15,5 s mm 15,5 s mm 15,5 s mm			
 Ac204	 Ac213	 Ac222	
46,5mm 15,5 s mm 31mm			
124	 Ac205	 Ac214	 Ac223
46,5mm 15,5 s mm 15,5 s mm 15,5 s mm 15,5 s mm 15,5 s mm			
 Ac206	 Ac215	 Ac224	
46,5mm 15,5 s mm 15,5 s mm 15,5 s mm 31mm			
 Ac207	 Ac216	 Ac225	
46,5mm 31mm 31mm 15,5 s mm			
155	 Ac208	 Ac217	 Ac226
46,5mm 15,5 s mm 15,5 s mm 15,5 s mm 15,5 s mm 15,5 s mm 31mm			
 Ac209	 Ac218	 Ac227	
46,5mm 31mm 31mm 31mm 15,5 s mm			
Extra	 Exa01	 Exa04	 Exa07
31mm			
 Exa02	 Exa05	 Exa08	
31s mm			
 Exa03	 Exa06	 Exa09	
15,5 s mm 15,5 s mm			

"S" indicates insert profiles

Note: These extra profiles can be used to extend the door or wall sign examples showed in this catalog.

For example: You need three door signs of 186mm length with classic end caps, five insert profiles of 15.5mm and one with three insert profiles of 15.5mm without lower profile.

Ellipse end caps – Door Signs

155mm			186mm			217mm			46.5
	Ae201			Ae210			Ae219	46.5mm	
155mm			186mm			217mm			62
	Ae202			Ae211			Ae220	46.5mm 15.5 s mm	
155mm			186mm			217mm			93
	Ae203			Ae212			Ae221	46.5mm 15.5 s mm 15.5 s mm 15.5 s mm	
	Ae204			Ae213			Ae222	46.5mm 15.5 s mm 31mm	
155mm			186mm			217mm			124
	Ae205			Ae214			Ae223	46.5mm 15.5 s mm 15.5 s mm 15.5 s mm 15.5 s mm 15.5 s mm	
	Ae206			Ae215			Ae224	46.5mm 15.5 s mm 15.5 s mm 15.5 s mm 31mm	
	Ae207			Ae216			Ae225	46.5mm 31mm 31mm 15.5 s mm	
155mm			186mm			217mm			155
	Ae208			Ae217			Ae226	46.5mm 15.5 s mm 15.5 s mm 15.5 s mm 15.5 s mm 15.5 s mm 31mm	
	Ae209			Ae218			Ae227	46.5mm 31mm 31mm 31mm 15.5 s mm	
155mm			186mm			217mm			Extra
	Exa10			Exa13			Exa16	31mm	
	Exa11			Exa14			Exa17	31s mm	
	Exa12			Exa15			Exa18	15.5 s mm 15.5 s mm	

Your order: 5x (Ac214)
1x (Ac212) =
Five classic door signs with a top profile of 46.5mm and five insert profiles of 15.5mm.
One classic door sign with a top profile of 46.5mm and three insert profiles of 15.5mm.

"S" indicates insert profiles

Classic end caps

Profile	93mm	186mm	400mm
93	93mm Ac301	186mm Ac302	400mm Ac303
	93mm s Ac304	186mm Ac305	400mm Ac306
124	124mm Ac307	248mm Ac308	400mm Ac309
	155mm Ac310	310mm Ac311	400mm Ac312
155	155mm s Ac313	310mm Ac314	400mm Ac315
	186mm Ac316	310mm Ac317	400mm Ac318
186	124mm Ac319	310mm Ac320	400mm Ac321
	62mm Ac322	310mm Ac323	400mm Ac324
217	124mm Ac322	310mm Ac323	400mm Ac324
	46mm Ac322	310mm Ac323	400mm Ac324

"S" indicates insert profiles

You can't find what you need? Contact us and we will help you to find the solution!

Ellipse end caps – Wall Signs

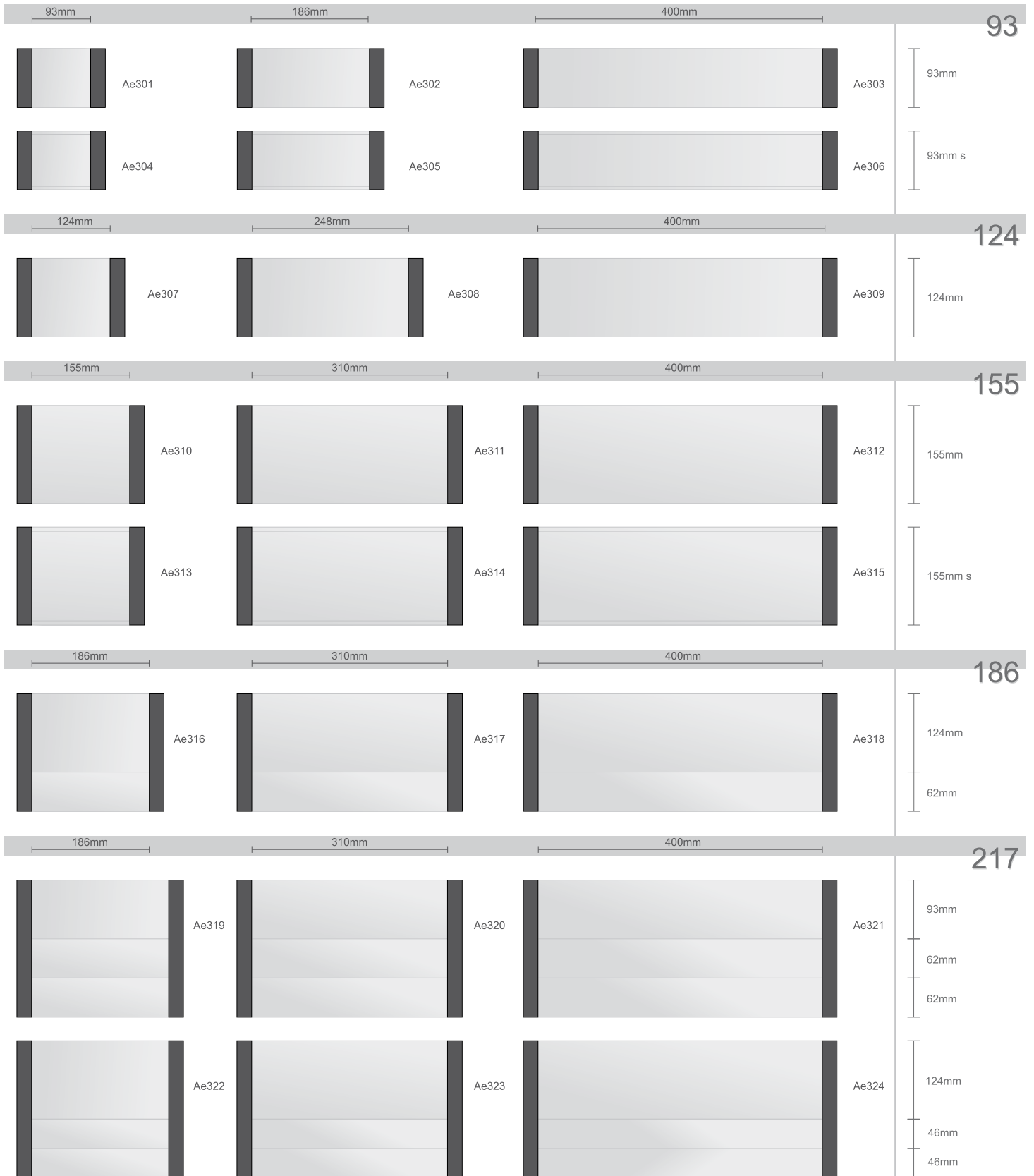

This is only a selection of the endless combination possibilities that the Triline® system offers.

"S" indicates insert profiles



A series of horizontal dotted lines providing a template for writing or drawing.

